

OPERATOR'S MANUAL

MST 488-27 POWER MODULE CONTROLLER

INTERACTIVE DIGITALLY CONTROLLED POWER MODULE SYSTEM

KEPCO INC.
An ISO 9001 Company.

MODEL MST 488-27 POWER MODULE CONTROLLER

ORDER NO. **M477440**

REV. NO. **11**

IMPORTANT NOTES:

- 1) This manual is valid for the following Model and associated serial numbers:

MODEL	SERIAL NO.	REV. NO.
-------	------------	----------
- 2) A Change Page may be included at the end of the manual. All applicable changes and revision number changes are documented with reference to the equipment serial numbers. Before using this Operator's Manual, check your equipment serial number to identify your model. If in doubt, contact your nearest Kepco Representative, or the Kepco Documentation Office in New York, (718) 461-7000, requesting the correct revision for your particular model and serial number.
- 3) The contents of this manual are protected by copyright. Reproduction of any part can be made only with the specific written permission of Kepco, Inc.

Data subject to change without notice.

©2000, KEPCO, INC
P/N 243-0865



KEPCO, INC. • 131-38 SANFORD AVENUE • FLUSHING, NY. 11352 U.S.A. • TEL (718) 461-7000 • FAX (718) 767-1102
email: hq@kepcopower.com • World Wide Web: <http://www.kepcopower.com>

Declaration of Conformity

Application of Council directives: **73/23/EEC (LVD)**
93/68/EEC (CE mark)

Standard to which Conformity is declared:

EN61010-1:1993 (Safety requirements for electrical equipment for measurement, control and laboratory use)

Manufacturer's Name and Address: **KEPCO INC.**
131-38 SANFORD AVENUE
FLUSHING, N.Y. 11352 USA

Importer's Name and Address:

REPRESENTATIVE COPY

Type of Equipment: **Component Power Supply**

Model No.: **[PRODUCT MODEL NUMBER]**

Year of Manufacture:

I, the undersigned, declare that the product specified above, when used in conjunction with the conditions of conformance set forth in the product instruction manual, complies with the requirements of the Low Voltage Directive 73/23/EEC, which forms the basis for application of the CE Mark to this product.

Place: **KEPCO Inc.**
131-38 Sanford Ave.
Flushing, N.Y. 11352 USA

Saul Kupferberg
(Full Name)

Date: _____

VP OF SALES
(position)

Conditions of Conformance Programming Module

When this product is used in applications governed by the requirements of the EEC, the following restrictions and conditions apply:

1. For European applications, requiring compliance to the Low Voltage Directive, 73/23/EEC, this power supply is considered a component product, designed for "built in" applications. Because it is incomplete in construction, the end product enclosure must provide for compliance to any remaining electrical safety requirements and act as a fire enclosure. (EN61010-1 Cl. 6, Cl. 7, Cl.8, Cl. 9 and EN61010-1 annex F)
2. This power supply is designed for stationary installation either within an equipment rack or a KEPCO Rack Adapter RA 55 or CA 400.
3. This power supply is considered a Class 1 (earthed) product, and as such depends upon proper connection to protective earth for safety from electric shock. (EN61010-1 Cl. 6.5.4)
4. This power supply is intended for use as part of equipment meant for test, measurement and laboratory use, and is designed to operate from single phase, three wire power systems. This equipment must be installed in a specifically designed KEPCO rack adapter and within a suitably wired equipment rack, utilizing a three wire (grounded) mains connection. See wiring section of this manual for complete electrical wiring instructions. (EN61010-1 Cl. 6.5.4 and Cl.6.10.1)
5. This power supply has secondary output circuits that are considered SELV.
6. This power supply employs a supplementary circuit protector in the form of a fuse mounted within its enclosure. The fuse protects the power supply itself from damage in the event of a fault condition. For complete circuit protection of the end product, as well as the building wiring, it is required that a primary circuit protection device be fitted to the branch circuit wiring. (EN61010-1 Cl. 9.6.2)
7. Hazardous voltages are present within this power supply during normal operation. All operator adjustments to the product are made via externally accessible switches, controls and signal lines as specified within the product operating instructions. There are no user or operator serviceable parts within the product enclosure. Refer all servicing to qualified and trained Kepco service technicians.

SAFETY INSTRUCTIONS

1. Installation, Operation and Service Precautions

This product is designed for use in accordance with EN 61010-1 and UL 3101 for Installation Category 2, Pollution Degree 2. Hazardous voltages are present within this product during normal operation. The product should never be operated with the cover removed unless equivalent protection of the operator from accidental contact with hazardous internal voltages is provided.



There are no operator serviceable parts or adjustments within the product enclosure. Refer all servicing to trained service technician.



Source power must be removed from the product prior to performing any servicing.



This product is designed for use with nominal a-c mains voltages indicated on the rating nameplate.

2. Grounding

This product is a Class 1 device which utilizes protective earthing to ensure operator safety.



The PROTECTIVE EARTHING CONDUCTOR TERMINAL must be properly connected prior to application of source power to the product (see instructions on installation herein) in order to ensure safety from electric shock.



PROTECTIVE EARTHING CONDUCTOR TERMINAL - This symbol indicates the point on the product to which the protective earthing conductor must be attached.



EARTH (GROUND) TERMINAL - This symbol is used to indicate a point which is connected to the PROTECTIVE EARTHING TERMINAL. The component installer/ assembler must ensure that this point is connected to the PROTECTIVE EARTHING TERMINAL.

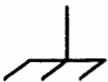

CHASSIS TERMINAL - This symbol indicates frame (chassis) connection, which is supplied as a point of convenience for performance purposes (see instructions on grounding herein). This is not to be confused with the protective earthing point, and may not be used in place of it.

3. Electric Shock Hazards

This product outputs hazardous voltage and energy levels as a function of normal operation. Operators must be trained in its use and exercise caution as well as common sense during use to prevent accidental shock.



This symbol appears adjacent to any external terminals at which hazardous voltage levels as high as 500V d-c may exist in the course of normal or single fault conditions.



This symbol appears adjacent to any external terminals at which hazardous voltage levels in excess of 500V d-c may exist in the course of normal or single fault conditions.

TABLE OF CONTENTS

SECTION	PAGE
SECTION 1 - INTRODUCTION	
1.1	Scope of Manual 1-1
1.2	General Description..... 1-1
1.3	Specifications 1-1
1.4	Equipment Supplied 1-4
1.5	Accessories 1-4
SECTION 2 - INSTALLATION	
2.1	Unpacking and Inspection 2-1
2.2	Installation 2-1
2.2.1	Set (GPIB) Device Address 2-1
2.2.2	Start-up Language/Compatibility Mode/GPIB Addressing Default 2-2
2.2.3	Set Shield Ground Jumper 2-3
2.2.4	Final System Interconnections..... 2-3
2.3	Rear Terminations on the MST 488-27 2-4
2.4	RS 232 Connections 2-6
SECTION 3 - OPERATION	
3.1	General..... 3-1
3.2	IEEE 488 (GPIB) Bus Protocol..... 3-1
3.2.1	String Parsing 3-2
3.3	RS 232 Operation..... 3-3
3.3.1	RS 232 With GPIB addressing 3-3
3.3.2	Serial Interface..... 3-3
3.3.3	RS 232 Implementation 3-4
3.3.3.1	Echo Mode..... 3-5
3.3.3.2	Prompt Method 3-5
3.3.3.3	XON XOFF Method..... 3-5
3.3.3.4	RS 232 Assistance..... 3-5
3.4	SCPI Programming 3-5
3.4.1	SCPI Messages 3-6
3.4.2	Common Commands/Queries 3-6
3.4.3	SCPI Subsystem Command/Query Structure..... 3-6
3.4.4	Program Message Structure..... 3-7
3.4.4.1	Keyword..... 3-8
3.4.4.2	Keyword Separator 3-10
3.4.4.3	Query Indicator 3-10
3.4.4.4	Data 3-10
3.4.4.5	Data Separator..... 3-10
3.4.4.6	Message Unit Separator 3-10
3.4.4.7	Root Specifier 3-10
3.4.5	Addressing Multiple Power Supplies 3-10
3.4.6	Understanding The Command Structure 3-11
3.4.7	Program Message Syntax Summary..... 3-12
3.4.8	STATUS REPORTING 3-12
3.4.8.1	STATUS REPORTING STRUCTURE 3-12
3.4.8.2	Operational Status Register..... 3-13
3.4.8.3	QUESTIONable Status Register..... 3-13
3.4.8.4	Multiple Logical Instruments 3-14
3.4.9	SCPI Program Example..... 3-16
3.5	CIL Programming 3-16

TABLE OF CONTENTS

SECTION		PAGE
APPENDIX A - IEEE 488.2 COMMAND/QUERY DEFINITIONS		
A.2	*CLS — Clear Status Command	A-1
A.3	*ESE — Standard Event Status Enable Command	A-1
A.4	*ESE? — Standard Event Status Enable Query	A-2
A.5	*ESR? — Event Status Register Query	A-2
A.6	*IDN? — Identification Query	A-2
A.7	*OPC — Operation Complete Command	A-2
A.8	*OPC? — Operation Complete Query	A-3
A.9	*OPT? — Options Query	A-3
A.10	*RST — Reset Command	A-4
A.11	*SRE — Service Request Enable Command	A-4
A.12	*SRE? — Service Request Enable Query	A-4
A.13	*STB? — Status Byte Register Query	A-4
A.14	*TRG — Trigger Command	A-4
A.15	*TST? — Self Test Query	A-5
A.16	*WAI — Wait-to-Continue Command	A-5

APPENDIX B - SCPI COMMAND/QUERY DEFINITIONS

B.2	INITiate[:IMMediate] Command	B-1
B.3	INITiate:CONTInuous Command	B-2
B.4	INITiate:CONTInuous Query	B-2
B.5	INSTRument:CATalog Query	B-2
B.6	INSTRument[:NSElect] Command	B-2
B.7	INSTRument[:SElect] Command	B-2
B.8	INSTRument[:SElect]? Query	B-3
B.9	INSTRument:STATe Command	B-3
B.10	MEASure[:SCALar]:CURRent[:DC]? Query	B-3
B.11	MEASure[:VOLTag[:SCALar]:[:DC]? Query	B-3
B.12	OUTPut[:STATe] Command	B-3
B.13	OUTPut[:STATe] Query	B-4
B.14	[SOURce:]CURRent[:LEVel][:IMMediate][:AMPLitude] Command	B-5
B.15	[SOURce:]CURRent[:LEVel][:IMMediate][:AMPLitude] Query	B-5
B.16	[SOURce:]CURRent[:LEVel]TRIGgered[:AMPLitude] Command	B-5
B.17	[SOURce:]CURRent[:LEVel]TRIGgered[:AMPLitude]? Query	B-5
B.18	[SOURce:]VOLTag[:LEVel][:IMMediate][:AMPLitude] Command	B-6
B.19	[SOURce:]VOLTag[:LEVel][:IMMediate][:AMPLitude]? Query	B-6
B.20	[SOURce:]VOLTag[:LEVel]TRIGgered[:AMPLitude] Command	B-6
B.21	[SOURce:]VOLTag[:LEVel]TRIGgered[:AMPLitude]? Query	B-6
B.22	[SOURce:]FUNctIon:MODE Command	B-6
B.23	STATus:OPERation:CONDition Query	B-6
B.24	STATus:OPERation:ENABle Command	B-7
B.25	STATus:OPERation:ENABle? Query	B-7
B.26	STATus:OPERation[:EVENT] Query	B-7
B.27	STATus:PRESet Command	B-7
B.28	STATus:QUESTionable[:EVENT]? Query	B-7
B.29	STATus:QUESTionable:CONDition? Query	B-8
B.30	STATus:QUESTionable:ENABle Command	B-9
B.31	STATus:QUESTionable:ENABle? Query	B-9
B.32	STATus:QUESTionable:INSTRument? Query	B-9
B.33	STATus:QUESTionable:INSTRument1? Query	B-9
B.34	STATus:QUESTionable:INSTRument2? Query	B-10
B.35	STATus:QUESTionable:INSTRument:ENABle Command	B-10
B.36	STATus:QUESTionable:INSTRument:ENABle Query	B-10
B.37	STATus:QUESTionable:INSTRument1:ENABle Command	B-10
B.38	STATus:QUESTionable:INSTRument1:ENABle? Query	B-11

TABLE OF CONTENTS

SECTION		PAGE
B.39	STATus:QUESTionable:INSTrument2:ENABle Command	B-11
B.40	STATus:QUESTionable:INSTrument2:ENABle? Query	B-11
B.41	STATus:QUESTionable:INSTrument:ISUM Query.....	B-11
B.42	STATus:QUESTionable:INSTrument:ISUM:ENABle Command.....	B-11
B.43	STATus:QUESTionable:INSTrument:ISUM:ENABle? Query	B-11
B.44	SYSTem:COMMunication:GPIB:ADDRess Command	B-12
B.45	SYSTem:COMMunication:SERial:BAUD Command.....	B-12
B.46	SYSTem:COMMunication:SERial:ECHO Command	B-12
B.47	SYSTem:COMMunication:SERial:PACE Command.....	B-12
B.48	SYSTem:COMMunication:SERial:PROMpt Command.....	B-12
B.49	SYSTem:ERRor[:NEXT]? Query	B-12
B.50	SYSTem:LANGuage Command.....	B-12
B.51	SYSTem:SET Command	B-13
B.52	SYSTem:VERSion Query.....	B-13

APPENDIX C - CIIL COMMAND DEFINITIONS

LIST OF FIGURES

FIGURE	TITLE	PAGE
1-1	MST488-27 Power Module Controller.....	iv
1-2	Remotely Controlled Power Supply Configurations Using Kepco Products.....	1-2
1-3	MST 488-27 Controller Outline Drawing	1-3
1-4	Controller to Power Module Interface (Typical).....	1-4
2-1	Configuration Controls.....	2-4
2-2	Front and Rear Panels of MST 488-27 Power Module Controller.....	2-5
3-1	RS 232 Implementation.....	3-4
3-2	Tree Diagram of SCPI Commands Used with MST 488-27 Controller	3-7
3-3	Message Structure	3-9
3-4	Status Reporting Structure	3-14
3-5	Expansion of QUESTIONable Register for Multiple Logical Instruments.....	3-15
3-6	Typical Example Of MST 488-27 Controller Program Using SCPI Commands.....	3-16
A-1	GPIB Commands	A-3
A-2	Using the *WAIto-continue Command	A-5
B-1	Use of INSTRument:CATalog Query	B-2
B-2	Programming the Output.....	B-4
B-3	Programming Current.....	B-5
B-4	Using Status Commands and Queries	B-8
C-1	FNC — Function Command	C-1
C-2	INX — Initiate Op Code Command	C-2
C-3	FTH — Fetch Command	C-2
C-4	SET Command.....	C-3
C-5	OPN, CLS — Open, Close Relay Commands	C-4
C-6	RST — Reset Command.....	C-4
C-7	CNF, IST — Confidence Test, Internal Self Test Commands	C-4
C-8	STA — Status Command	C-5

LIST OF TABLES

TABLE	TITLE	PAGE
1-1	General Specifications for MST 488-27 Controller	1-1
1-2	Accessories	1-4
2-1	Device Address Selection	2-2
2-2	Start-up Language/Compatibility Mode/GPIB Addressing Selection	2-3
2-3	Compatibility Mode Differences	2-3
2-4	Input/Output Pin Assignments	2-6
3-1	IEEE 488 (GPIB) Bus Interface Functions	3-1
3-2	IEEE 488 (GPIB) Bus Command Mode Messages	3-2
3-3	IEEE 488 (GPIB) Bus Data Mode Messages	3-2
3-4	SCPI Command Index	3-8
3-5	Rules Governing Shortform Keywords	3-9
A-2	Standard Event Status Enable Register and Standard Event Status Register Bits	A-1
A-1	IEEE 488.2 Command/query Index	A-1
A-3	Service Request Enable and Status Byte Register Bits	A-4
B-1	SCPI Subsystem Command/query Index	B-1
B-2	Operation Condition Register, Operation Enable Register, and Operation Event Register Bits	B-7
B-3	Questionable Event Register, Questionable Condition Register and Questionable Condition Enable Register Bits	B-8
B-4	Questionable Instrument Register 0 Bits	B-9
B-5	Questionable Instrument Register 1 Bits	B-10
B-6	Questionable Instrument Register 2 Bits	B-10
B-7	Error Messages	B-13
C-1	CIIL Subsystem Command/query Index	C-1
C-2	CIIL Error Messages	C-5

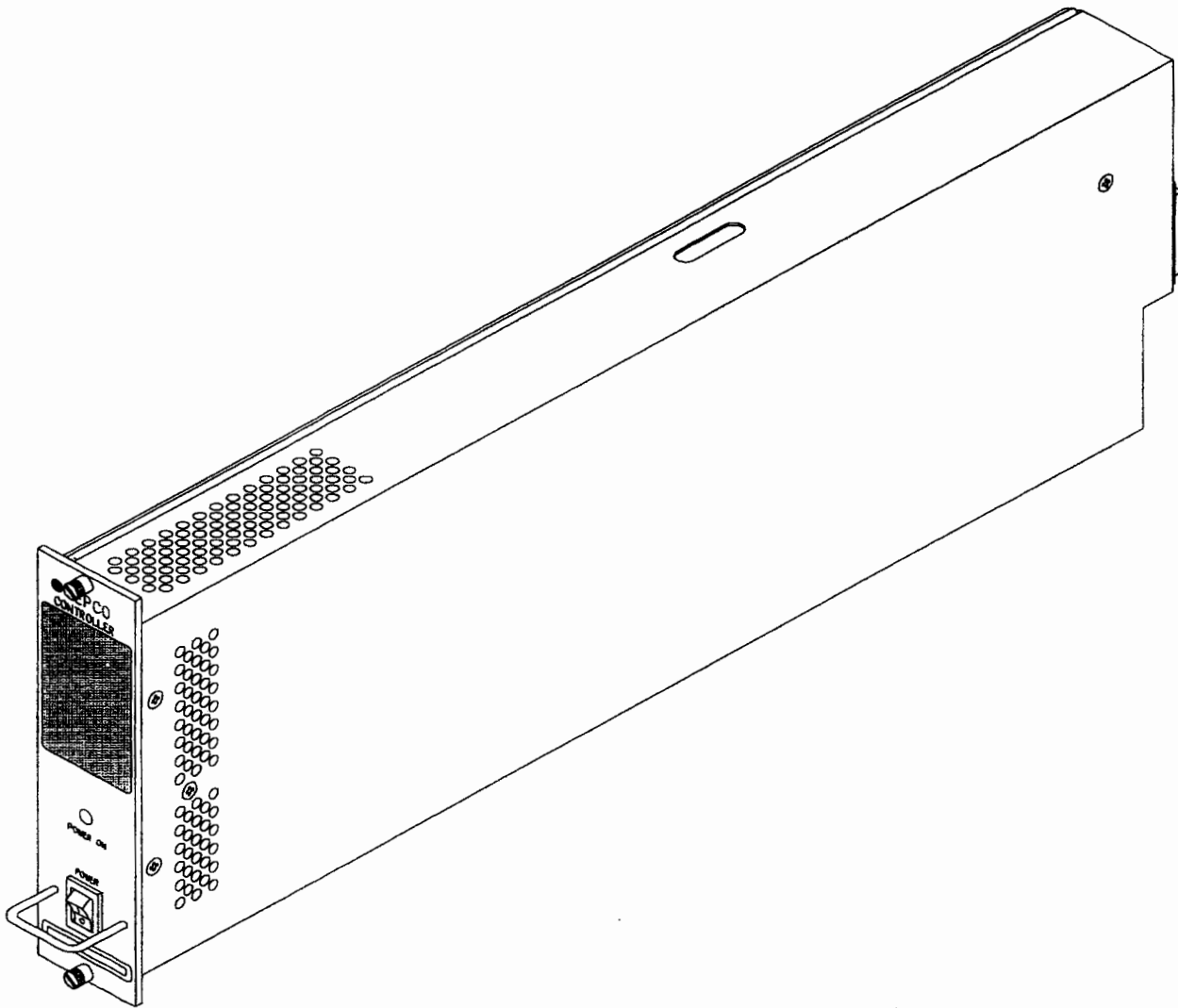

3041118

FIGURE 1-1. MST488-27 POWER MODULE CONTROLLER

SECTION 1 - INTRODUCTION

1.1 SCOPE OF MANUAL

This operator's manual contains the specifications and instructions for the installation and operation of the Model MST 488-27 Power Module Controller (Figure 1-1), manufactured by Kepco, Inc., Flushing, N.Y. U.S.A..

1.2 GENERAL DESCRIPTION

The Kepco model MST 488-27 is a Power Module Controller which has the capability to program, control and monitor the outputs of up to 27 Kepco MAT, MBT, MST or BOP power supplies (power modules). The MST 488-27 communicates with its Host computer over the IEEE 488 bus (GPIB) using either CIL (Control Interface Intermediate Language) or SCPI (Standard Commands for Programmable Instruments) Languages. An auxiliary input port allows for communication via the RS 232-C (EIA 232) standard serial communications bus. The MST 488-27 communicates with the MAT, MBT, MST or BOP series using the IEEE1118 two-wire serial bus, hereafter referred to as the Control Bus, which allows control over distances up to a maximum of 1000 feet (300 meters) (see Figure 1-2).

The IEEE 488 GPIB interface functions implemented by the controller are defined by the IEEE 488 Standard, and described in Table 3-1.

The MST 488-27 Controller interfaces to an MST power module via either the RA 55 or CA 400 Rack Adapter; interconnection to the Host Computer on the GPIB is made via an IEEE 488 standard cable. If the serial port is used for communications between the controller and a computer terminal, a 9 pin null-modem RS 232-C connector/cable is required.

The MST 488-27 Controller is comprised of a single-board computer (SBC) and power supply housed in a 1/9 Rack (7" high by 1-3/4" wide by 20-1/4" deep) case (see Figure 1-3).

1.3 SPECIFICATIONS (REFER TO FIGURE 1-3 AND TABLE 1-1)

The Host Computer can set the output voltage with current limit, or the output current with voltage limit. The Host Computer can then have the MST 488-27 read back the actual output voltage and current delivered by each of the MST power modules to their respective loads. The MST 488-27 is continually polling all of the power modules on the Control Bus for flags of catastrophic and noncatastrophic errors. All data transmissions over the GPIB are ASCII encoded. The values for the command parameters can be written in integer, decimal or scientific notation. The responses from the MST 488-27 are detailed in Section 3 of this manual.

TABLE 1-1. GENERAL SPECIFICATIONS FOR MST 488-27 CONTROLLER

FEATURE	SPECIFICATION
A-C Input Requirements	95 to 264V a-c, 47 to 63 Hz, approximately 12 Watts maximum
Ambient Operating Temperature Range	0 to +55° C
Storage Temperature Range	-20 to +75° C
Dimensions	7" H x 1-3/4" W x 20-1/4" D
Color (front panel)	Kepco gray, Hartin Paint No. 15-22493
Mounting	Rack Adapter (Kepco RA 55 or CA 400)

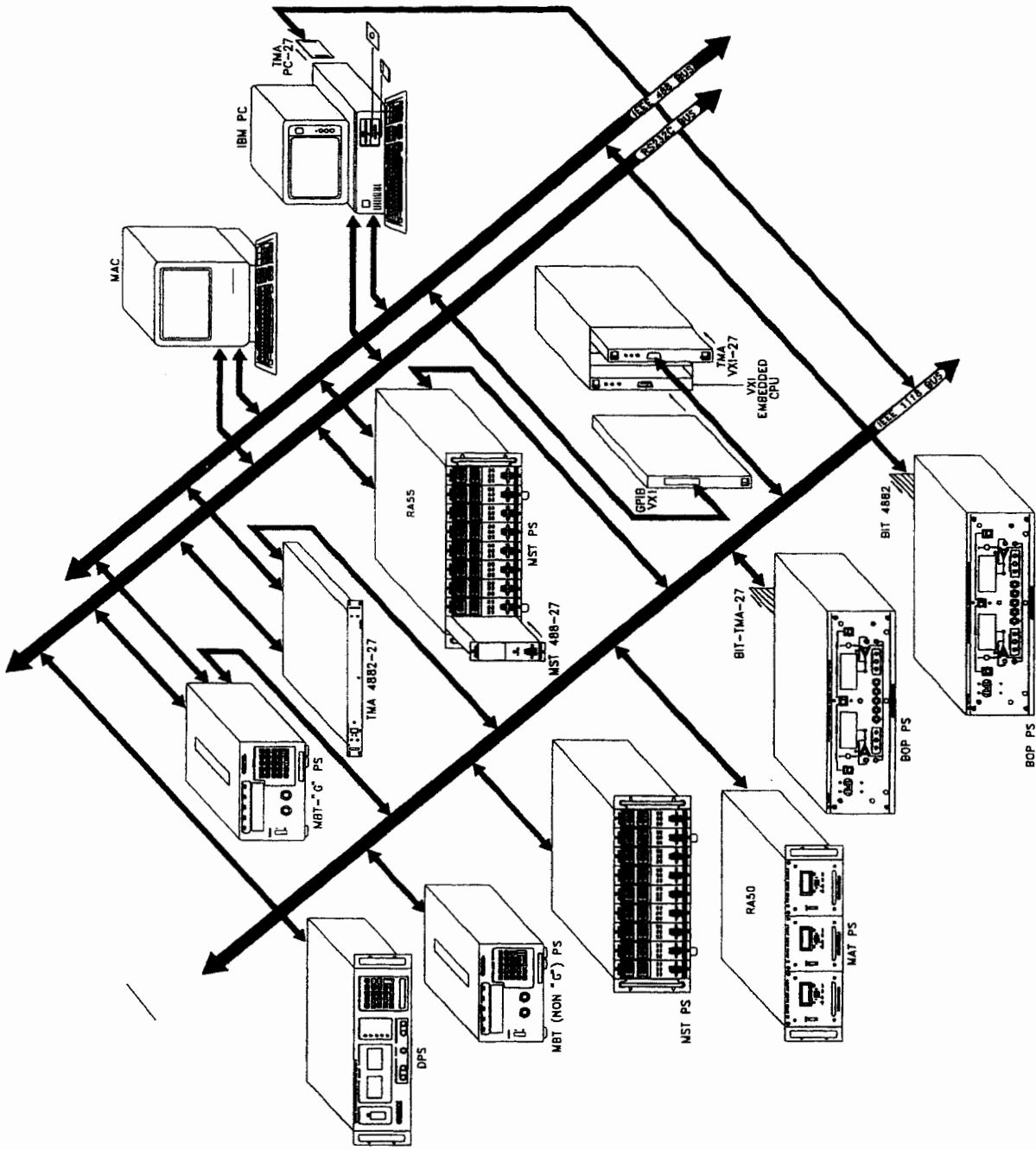
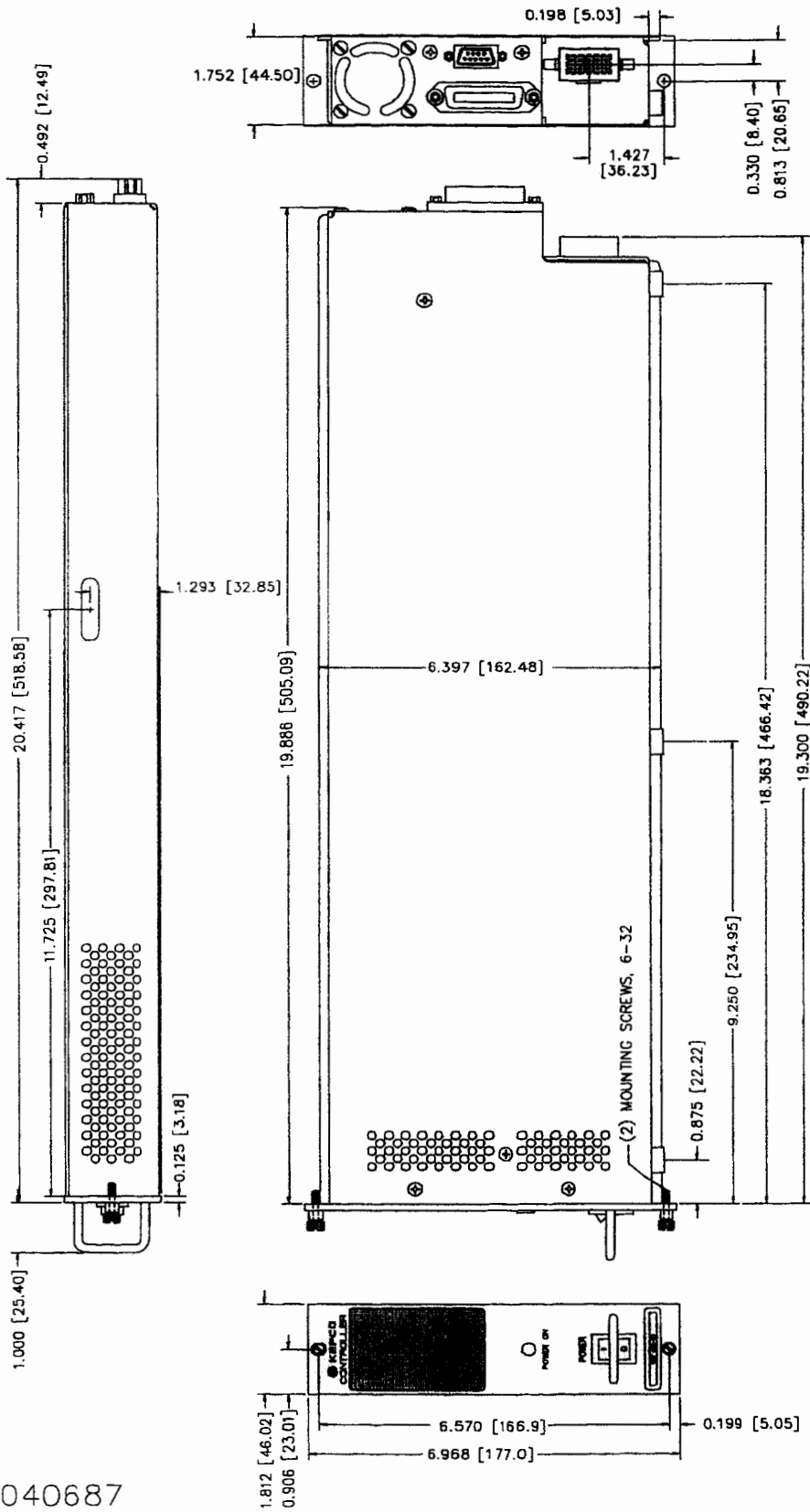

FIGURE 1-2. REMOTELY CONTROLLED POWER SUPPLY CONFIGURATIONS USING KEPCO PRODUCTS

3040687



- NOTES:
- MATERIAL:
 - A) CHASSIS & COVER: 0.064 THK. ALUM. 5052-H32.
 - B) FRONT PANEL: 0.125 THK. ALUM. 5081-T6.
 - FINISH:
 - A) CHASSIS & COVER: YELLOW IRIDITE.
 - B) FRONT PANEL: KEPCO GRAY, HARTIN PAINT #15-22493.
 - DIMENSIONS IN PARENTHESES ARE IN MILLIMETERS.
 - TOLERANCES:
 - A) BETWEEN MOUNTING HOLES: $\pm 1/64(\pm 0.4)$.
 - B) ALL OTHER DIMENSIONS: $\pm 1/32(\pm 0.8)$ EXCEPT AS NOTED.

FIGURE 1-3. MST 488-27 CONTROLLER OUTLINE DRAWING

1.4 EQUIPMENT SUPPLIED

A terminator, Kepco P/N 195-0086, is included with each controller to provide proper termination of the IEEE 1118 control bus. In configurations where power modules are daisy chained on the IEEE 1118 control bus (see Figure 1-4), the last power module control bus outlet (in the daisy chain) must be terminated with the IEEE Control Bus Terminator supplied with the controller to reduce spurious noise and provide proper impedance matching.

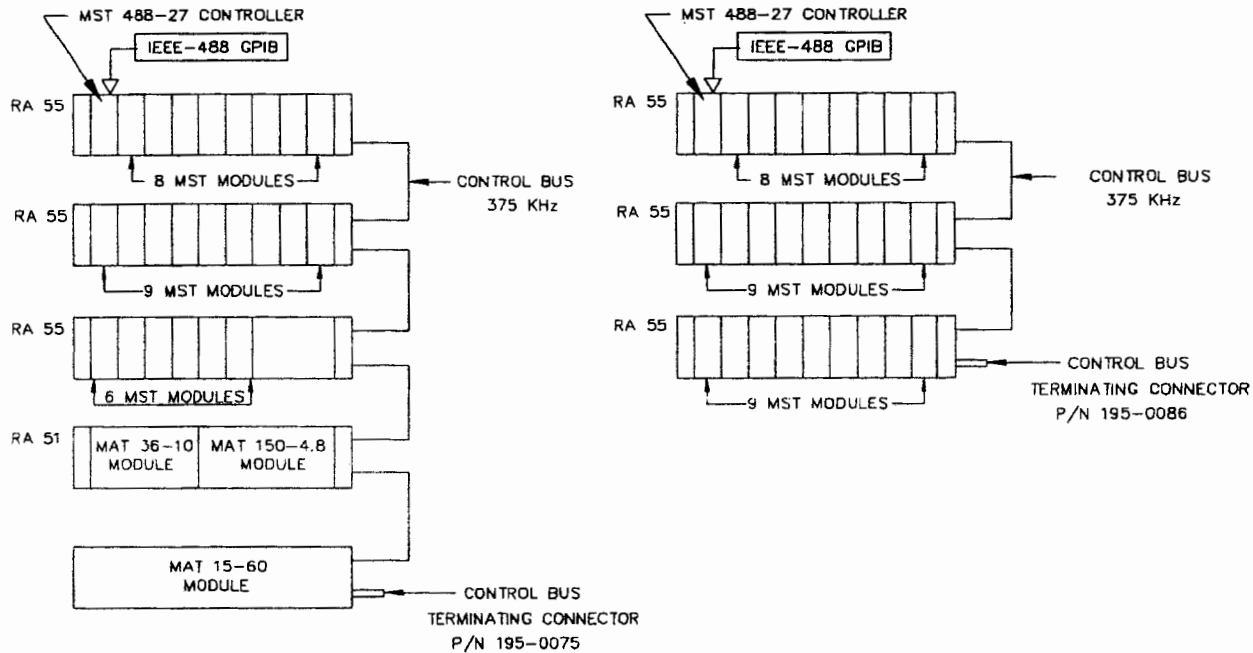

- NOTES: 1. MAXIMUM OF 27 UNITS CAN BE CONTROLLED (ANY COMBINATION)
 2. TERMINATOR MUST BE CONNECTED EVEN IF ONLY ONE RACK ADAPTER USED.
 3. CONFIGURATIONS OTHER THAN DAISY CHAIN NOT SUPPORTED.

3041128

FIGURE 1-4. CONTROLLER TO POWER MODULE INTERFACE (TYPICAL)

1.5 ACCESSORIES

Accessories for the MST 488-27 are listed in Table 1-2.

TABLE 1-2. ACCESSORIES

ITEM	FUNCTION	PART NUMBER
Terminator - 5-pin connector	Termination for daisy chain on IEEE 1118 bus.	195-0075
Terminator - 9-pin connector		195-0086
Cable - two 5-pin connectors	Daisy chain Kepco Power Supplies with 5-pin connectors on IEEE 1118 bus.	118-0699
Cable - one 5-pin and one 9-pin connector, ~6 ft. (2 m)	Daisy chain MST 488-27 and Kepco Power Supplies with 5-pin connector on IEEE 1118 bus.	118-0749
Cable - one 5-pin and one 9-pin connector, ~12 ft. (4 m)		118-0852
Cable - two 9-pin connectors, ~ 6 ft. (2 m)	Daisy chain MST 488-27 and Kepco Power Supplies with 9-pin connector on IEEE 1118 bus.	118-0844
Cable - two 9-pin connectors, ~ 12 ft. (4 m)		118-0853

SECTION 2 - INSTALLATION

2.1 UNPACKING AND INSPECTION

The Model MST 488-27 has been carefully inspected and tested prior to packing. Inspect the shipping carton upon receipt for evidence of damage during transit. Save the original packing material. If any indication of damage is found, file a claim immediately with the responsible transport service.

For repairs of a product damaged in shipment, contact the Kepco Factory Representative nearest you or the Kepco Sales Department directly for further instruction.

2.2 INSTALLATION

The installation and set-up procedure for the MST 488-27 consists of the following steps:

1. Set Device Address Selector (PAR. 2.2.1).
2. Select start-up language (SCPI or CIL), GPIB addressing (Primary/Secondary) and Compatibility Mode (PAR. 2.2.2).
3. Set Shield Ground Jumper (PAR. 2.2.3).
4. Perform final system interconnections (PAR. 2.2.4).

2.2.1 SET (GPIB) DEVICE ADDRESS (SEE FIGURE 2-1)

The Device Address for the MST 488-27 is initially set by means of DIP switches accessible through an access hole on the top. The Device Address is the permanent Listener or Talker address of the MST 488-27 on the GPIB. It is factory preset to address 6. If a different Device Address is required in your system, proceed as follows. There are 31 (0-30) possible choices (See Table 2-1).

1. Place MST 488-27 power module controller with the top of the unit facing you, front panel to the right.
2. The Device Address DIP switches are positions 1 through 5 (from right to left). These switches are preset by Kepco to address 6. For other device addresses set them according to Table 2-1.

NOTE: To set the GPIB address when using RS232 operation, refer to PAR. 3.3.1.

TABLE 2-1. DEVICE ADDRESS SELECTION

DECIMAL ADDRESS	SELECTOR SWITCH SECTION (SIGNAL LINE)				
	A5	A4	A3	A2	A1
0	0	0	0	0	0
1	0	0	0	0	1
2	0	0	0	1	0
3	0	0	0	1	1
4	0	0	1	0	0
5	0	0	1	0	1
6	0	0	1	1	0
7	0	0	1	1	1
8	0	1	0	0	0
9	0	1	0	0	1
10	0	1	0	1	0
11	0	1	0	1	1
12	0	1	1	0	0
13	0	1	1	0	1
14	0	1	1	1	0
15	0	1	1	1	1
16	1	0	0	0	0
17	1	0	0	0	1
18	1	0	0	1	0
19	1	0	0	1	1
20	1	0	1	0	0
21	1	0	1	0	1
22	1	0	1	1	0
23	1	0	1	1	1
24	1	1	0	0	0
25	1	1	0	0	1
26	1	1	0	1	0
27	1	1	0	1	1
28	1	1	1	0	0
29	1	1	1	0	1
30	1	1	1	1	0

2.2.2 START-UP LANGUAGE/COMPATIBILITY MODE/GPIB ADDRESSING DEFAULT (SEE FIGURE 2-1)

Program Mode Bits P1 (DIP switch position A6, see Figure 2-1) and P2 (position A7) control the start-up command language, secondary GPIB addressing with SCPI, and Compatibility Mode as defined in Table 2-2.

Language - Selection is provided to choose either SCPI or CiIL command language. If SCPI is selected, you can also choose to implement either primary or secondary GPIB addressing.

Compatibility Mode - Certain features of the MST 488-27 can be configured to be fully 488.2/SCPI compatible (Mode 0) or to be backward compatible with previous Kepco products (Mode 1). Differences between Mode 0 and Mode 1 functionality are explained in Table 2-3.

TABLE 2-2. START-UP LANGUAGE/COMPATIBILITY MODE/GPIB ADDRESSING SELECTION

P1	P2	LANGUAGE	COMPATIBILITY MODE (See Table 2-3)	GPIB ADDRESSING
0*	0*	SCPI	MODE 1	Primary
0	1	CIIL	Not Applicable	Not Applicable
1	0	SCPI	MODE 1	Secondary
1	1	SCPI	MODE 0	Primary**

* Factory Default Configuration = P1 and P2 set to 0.
 ** In this mode, secondary addressing may be enabled by putting a jumper between DSR and RTS of the RS 232 port (pins 6 and 7).

TABLE 2-3. COMPATIBILITY MODE DIFFERENCES

FUNCTION	MODE 0 (fully 488.2/SCPI compatible)	MODE 1 (backward compatible with previous Kepco products)
Device Clear	Clears internal registers but leaves output voltage and current unchanged.	Clears internal registers, sets output voltage and current to zero, sets output to OFF, and, if unit incorporates relays, opens relays.
Status	Uses Status Instrument Registers.	Does not use Status Instrument Registers.
PON enable	All status register enables are set to 0.	All status register enables are set to 32767.
SYST:VERS?	Returns 1997.0.	Returns blank string.

2.2.3 SET SHIELD GROUND JUMPER (SEE FIGURE 2-1)

The jumper sets the Shield Ground state for the AC/control bus connector and is accessible after the cover is removed:

- JUMPER INSTALLED = shield grounded (factory default)
- JUMPER REMOVED = shield not grounded

2.2.4 FINAL SYSTEM INTERCONNECTIONS

1. Install the MST 488-27 in the left-most slot of the RA 55 or CA 400 Rack Adapter in accordance with instructions contained in the Rack Adapter manual (a connector must be removed to accommodate the MST 488-27 controller).
2. Install all power modules in the Rack Adapter
3. Connect the MST 488-27 to the GPIB or RS 232-C bus. Connection of both GPIB and RS 232 ports simultaneously is not recommended.

4. All power module outputs should be connected to their respective loads. For MST Power Module Calibration see the MST Operator's Manual.
5. Connect input power to the Rack Adapter in accordance with the Rack Adapter manual.

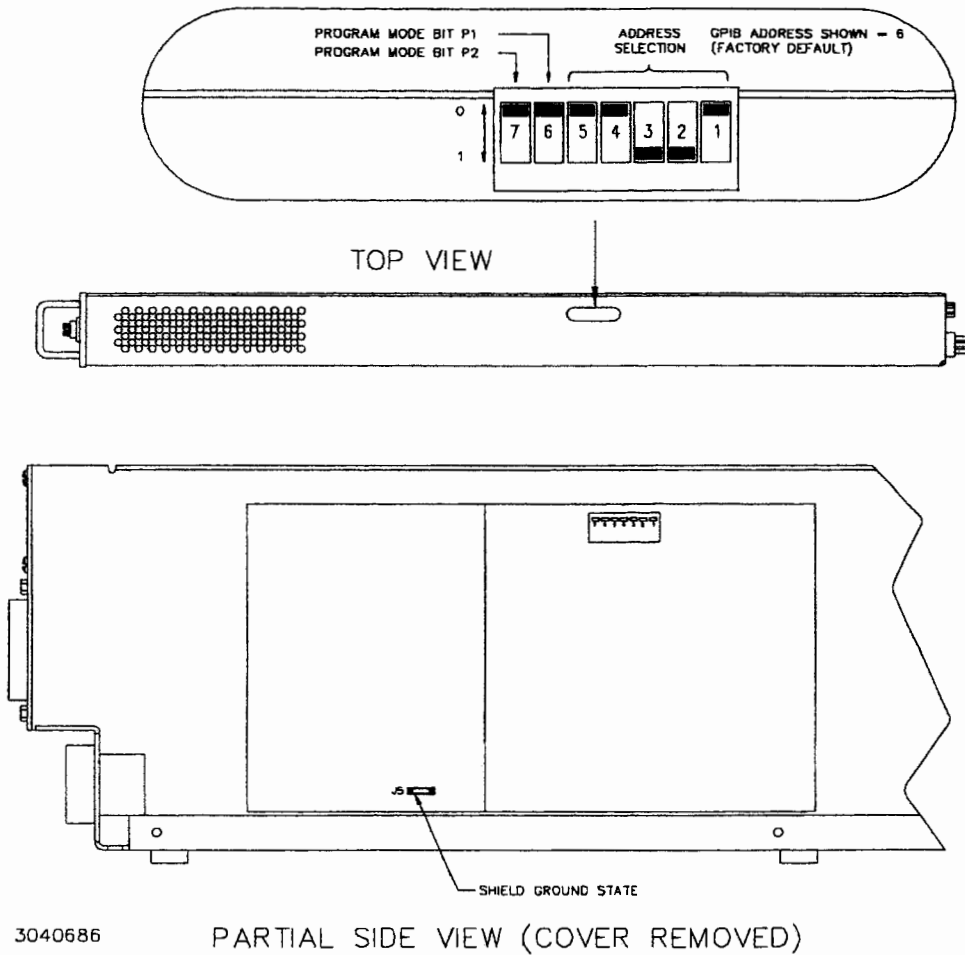
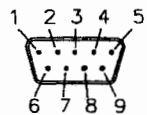
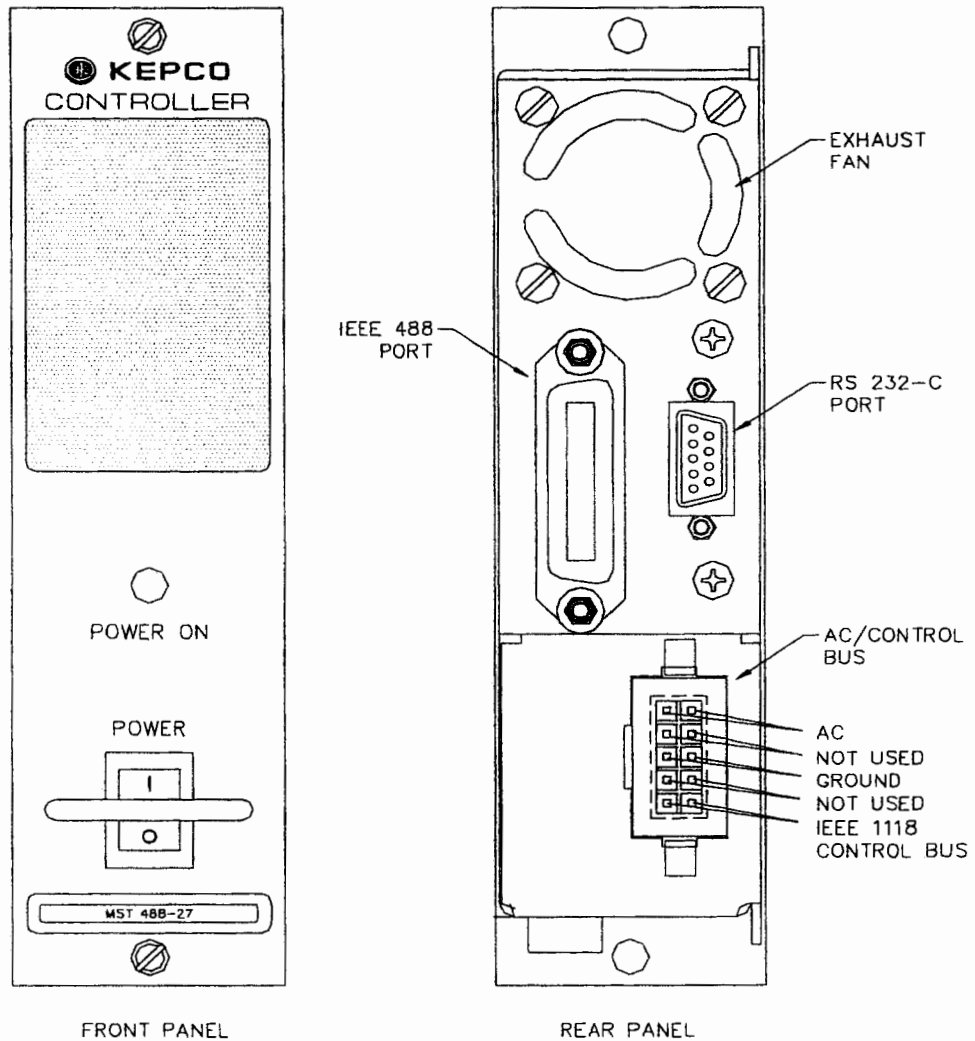

FIGURE 2-1. CONFIGURATION CONTROLS

2.3 REAR TERMINATIONS ON THE MST 488-27 (SEE FIGURE 2-2)

- a. **AC INPUT.** The MST 488-27 draws power from the same source used to power the MST power modules. Power is applied through the Rack Adapter via the AC/control bus connector.
- b. **IEEE 488 BUS.** This port is a 24 pin IEEE 488 connector and conforms mechanically and electrically to the IEEE 488 standard. Refer to Table 2-4 for pin assignments.

c. RS 232-C PORT. This port is a standard 9 pin RS 232-C (male) connector). Refer to Table 2-4 for pin assignments and PAR. 2.4 for additional information.



3040685

RS 232 PORT

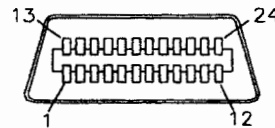

IEEE 488 PORT

FIGURE 2-2. FRONT AND REAR PANELS OF MST 488-27 POWER MODULE CONTROLLER

TABLE 2-4. INPUT/OUTPUT PIN ASSIGNMENTS

CONNECTOR	PIN	SIGNAL NAME	FUNCTION
RS232-C PORT	1	SGND	Signal Ground
	2	RXD	Receive Data
	3	TXD	Transmit Data
	4	DTR	Data Terminal Ready (protocol not used)
	5	SGND	Signal Ground
	6	DSR	Data Set Ready (protocol not used)
	7	RTS	Request To Send (protocol not used)
	8	CTS	Clear To Send (protocol not used)
	9	SGND	Signal Ground
IEEE 488 PORT	1	DI01	I/O Line
	2	DI02	I/O Line
	3	DI03	I/O Line
	4	DI04	I/O Line
	5	EOI	End or Identify
	6	DAV	Data Valid
	7	NRFD	Not Ready for Data
	8	NDAC	Not Data Accepted
	9	IFC	Interface Clear
	10	SRQ	Service Request
	11	ATN	Attention
	12	SHIELD	Shield
	13	DI05	I/O Line
	14	DI06	I/O Line
	15	DI07	I/O Line
	16	DI08	I/O Line
	17	REN	Remote Enable
	18	GND	Ground (signal common)
	19	GND	Ground (signal common)
	20	GND	Ground (signal common)
	21	GND	Ground (signal common)
	22	GND	Ground (signal common)
	23	GND	Ground (signal common)
	24	LOGIC GND	Logic Ground

2.4 RS 232 CONNECTIONS

Since the MST 488-27 uses a 9-pin male connector, it is classified as a Data Terminal Equipment (DTE) in accordance with the RS 232 Standard (equipment using a female connector is classified as Data Communication Equipment, DCE).

Either a DTE to DTE or a null modem cable is required to connect the MST 488-27 to an IBM-PC compatible computer. This cable has only three wires and connects RXD at one end to TXD at the other end. The RS232-C port control lines (Table 2-4) are used to activate special feature by means of jumpers; refer to Table 2-2 and PAR. 3.3 for details. Refer to PAR. 3.3 for RS 232 operation.

SECTION 3 - OPERATION

3.1 GENERAL

Kepeco MST 488-27 Power Module Controller is programmed over a control bus using either SCPI (Standard Commands for Programmable Instruments) or CIL (Control Interface Intermediate Language) commands. SCPI and CIL provide a common language used in an automatic test system.

The control bus can be either the IEEE 488 standard communication bus (General Purpose Interface Bus, GPIB), or the RS 232C communication bus. (Refer to Table 2-4 for input/output signal allocations.) Connection of both GPIB and RS 232 ports simultaneously is not recommended.

NOTE: Upon power loss, all programmed values/configurations are lost and must be reprogrammed.

3.2 IEEE 488 (GPIB) BUS PROTOCOL

Table 3-1 defines the interface capabilities of the MST 488-27 controller (Talker/Listener) relative to the IEEE 488 (GPIB) bus (reference document *ANSI/IEEE Std 488: IEEE Standard Digital Interface for Programmable Instrumentation*) communicating with a Host Computer-Controller (Talker/Listener).

TABLE 3-1. IEEE 488 (GPIB) BUS INTERFACE FUNCTIONS

FUNCTION	SUBSET SYMBOL	COMMENTS
Source Handshake	SH1	Complete Capability (Interface can receive multiline messages)
Acceptor Handshake	AH1	Complete Capability (Interface can receive multiline messages)
Talker	T6	Basic talker, serial poll, unaddress if MLA (My Listen Address) (one-byte address)
Listener	L4	Basic listener, unaddress if MTA (My Talk Address) (one-byte address).
Service Request	SR1	Complete Capability. The interface sets the SRQ line true if there is an enabled service request condition.
Remote/Local	RL2	No Local lock-out.
Parallel Poll	PP0	No Capability
Device Clear	DC1	Complete Capability. DCL (Device Clear) and SDC (Selected Device Clear) supported.
Device Trigger	DT1	GET supported.
Controller	C0	No Capability

Tables 3-2 and 3-3 define the messages sent to the MST 488-27, or received by the MST 488-27, via the IEEE 488 bus in IEEE 488 command mode and IEEE 488 data mode, respectively. These messages are enabled during the "handshake" cycle, with the MST 488-27 controller operating as either a Talker or a Listener.

3.2.1 STRING PARSING

When the MST 488-27 is in listen mode, strings are accepted. When the host controller sends the last byte it can assert the EOI line to indicate the string is complete. The GPIB listener function automatically adds a LF to terminate the string input. The parsing software then processes the string and if there are valid commands, the power supply is updated with the new control input. Some GPIB host controllers do not have the ability to assert the EOI control line, however the GPIB listener function will also terminate the string input when either a carriage return (0d_H) or Line Feed (0A_H) character is received.

TABLE 3-2. IEEE 488 (GPIB) BUS COMMAND MODE MESSAGES

MNEMONIC	MESSAGE DESCRIPTION	COMMENTS
ATN	Attention	Received
DAC	Data accepted	Received or Sent
DAV	Data Valid	Received or Sent
DCL	Device Clear	Received
IFC	Interface Clear	Received
MLA	My Listen Address	Received
MTA	My Talk Address	Received
OTA	Other Talk Address	Received
RFD	Ready for Data	Received or Sent
SDC	Selected Device Clear	Received
SPD	Serial Poll Disable	Received
SPE	Serial Poll Enable	Received
SRQ	Service Request	Sent
UNL	Unlisten	Received
UNT	Untalk	Received

TABLE 3-3. IEEE 488 (GPIB) BUS DATA MODE MESSAGES

MNEMONIC	MESSAGE DESCRIPTION	COMMENTS
DAB	Data Byte	Received or Sent
END	End	Received or Sent
EOS	End of String	Received or Sent
RQS	Request Service	Sent
STB	Status Byte	Sent

3.3 RS 232 OPERATION

The MST 488-27 controller may be operated via an RS 232-C terminal, or from a PC using a terminal emulation program. The default settings are as follows:

- Baud rate: 9600 (no jumper between RTS and CTS on RS 232 port)
- Parity: None
- Data Bits 8
- Stop Bits 1
- Echo ON
- XON OFF

When a jumper on the RS 232 port (RTS, CTS) is present, the GPIB address switch settings determine XON, echo, and baud rate as follows:

- Bit 5, 4 - baud rate (00 = 9600, 11 = 19200, 10 = 4800, 01 = 2400)
- Bit 3 - Echo (1 = enable; 0 = disable)
- Bit 2 - XON (1 = disable; 0 = enable)
- Bit 1 - Not used for RS 232 configuration; only affects GPIB Address (see PAR.3.3.1).

NOTE: The RTS to CTS jumper must be installed externally, on the cable

3.3.1 RS 232 WITH GPIB ADDRESSING

The GPIB will continue to function normally, using the RS 232 configuration of the GPIB address switch settings as the GPIB address (see also PAR. 2.2.1). If both GPIB and RS 232 will be used and a GPIB address different than that required for RS 232 configuration is needed, the GPIB address can be changed via RS 232 using the "syst:comm:gpi:addr n" command. This allows the GPIB address switch to determine the RS 232 configuration while the software command establishes the GPIB address.

3.3.2 SERIAL INTERFACE

The serial interface behaves like the GPIB interface in that the command is parsed after receiving a control character of either a Line Feed or Carriage Return. The serial interface supports six special control characters. The six special control characters are:

Escape (1B _H)	Causes the input buffer to be cleared. This character is used to ensure that the buffer is empty when the host powers on since it is possible that the MST was previously powered on and received some characters prior to the initialization of the host computer.
Backspace (08 _H)	Causes the last character in the input buffer to be removed from the input buffer queue.
Carriage Return (0D _H)	Causes the input buffer to be parsed by the MST 488-27 controller.
Line Feed (0A _H)	Causes the input buffer to be parsed by the MST 488-27 controller.

> and <

The > character turns on the echo mode upon receipt of the character. The < character turns off the echo mode. The message "echo off" or "echo on" will be displayed to confirm this.

3.3.3 RS 232 IMPLEMENTATION

The following paragraphs are provided to help the user understand how the RS 232 serial interface is implemented in the MST 488-27. Since the RS 232 protocol does not use a parity bit, the echo mode is the default method used to ensure reliable communication between the command originator (computer) and the MST 488-27 power supply controller, thus avoiding a more complex "handshake" protocol.

When the MST 488-27 controller is in the RS 232 echo mode it returns all data sent to the host controller. The MST 488-27 provides two additional options that allow handshake communication: the Prompt method and the XON XOFF method. In standard echo mode the controller must verify that each character is echoed back by the MST 488-27. As shown in Figure 3-1, there are times when the MST 488-27 does not echo back the character from the controller, requiring that the controller resend the character. By using the handshake options (prompt and XON XOFF) the host controller can ensure that serial data interrupts occurring after parsing of the incoming message do not result in lost data.

Figure 3-1 illustrates the default echo mode, the prompt method and the XON XOFF method described in the following paragraphs.

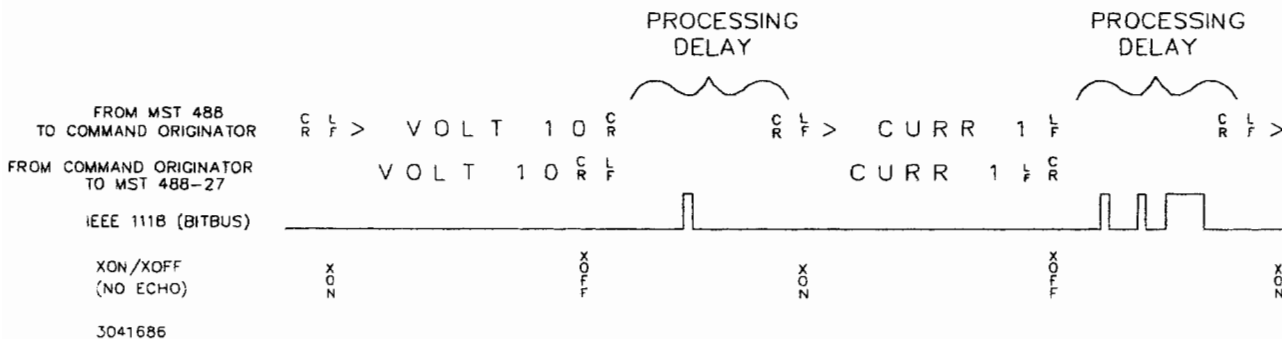

FIGURE 3-1. RS 232 IMPLEMENTATION

Only four control characters (characters between 00_H and 1F_H) are acknowledged by the power supply:

- Carriage Return (CR, 0D_H)
- Line Feed (LF, 0A_H)
- Back Space (BS, 08_H)
- Escape (ESC, 01B_H)

BS deletes the last character entered, with the exception of CR or LF characters. Either the CR or LF character acts as the line terminator, initiating parsing of the ASCII data sent to the MST 488-27 by the command originator. When the line is parsed and the commands are sent to the individual power supplies via the IEEE 1118 bus, the MST 488-27 sends the line terminator sequence CR LF to the command originator.

The ESC character is used for synchronization, causing the MST 488-27 to reset its input buffer and return a CR LF sequence.

All non-control characters are sent via the serial port of the command originator. The control character BS is echoed as BS Space BS. Only the first control character is returned in response to either a CR LF or LF CR character sequence (see Figure 3-1).

3.3.3.1 ECHO MODE

Echo mode is the default method of ensuring data is transferred without errors. Each byte (character) is echoed back to the sender where it is verified as the same character that was just sent. If the character is incorrect or missing, the sender sends the character again until the correct character is verified as having been received.

All non-control characters are sent via the serial port of the command originator. The control character BS is echoed as BS Space BS. Only the first control character is returned in response to either a CR LF or LF CR character sequence (see Figure 3-1).

3.3.3.2 PROMPT METHOD

The command originator sends a message line (command) to the MST 488-27 and waits until the prompt sequence CR LF > (3E_H, 62₁₀) is received. The MST 488-27 sends the prompt sequence CR LF > to the command originator indicating the power supply is ready to receive the next command and data will not be lost. The prompt method is similar to the echo method described above, except that the command originator does not have to compare each character and repeat any characters dropped while the IEEE 1118 bus (BITBUS) is active. The operation of the MST 488-27 is identical for echo mode and prompt mode; implementation of prompt mode is at the command originator.

3.3.3.3 XON XOFF METHOD

The XON XOFF method allows the MST 488-27 to control when the command originator is allowed to send data. The command originator can only send data after the XON (transmission on) character (011_H) has been received; the command originator stops sending data after receiving the XOFF (transmission off) character (013_H), and waits until the XON character is received before sending additional data.

Control characters, either CR or LF, are returned as XOFF CR if echo mode is on, and as XOFF if echo mode is off. XOFF stops data from the command originator and the MST 488-27 returns the normal sequence of CR LF (if echo mode is enabled).

3.3.3.4 RS 232 ASSISTANCE

If additional assistance is needed for RS 232 implementation, contact Kepco Applications Engineering.

3.4 SCPI PROGRAMMING

SCPI (Standard Commands for Programmable Instruments) is a programming language conforming to the protocols and standards established by IEEE 488.2 (reference document *ANSI/IEEE Std 488.2, IEEE Standard Codes, Formats, Protocols, and Common Commands*). SCPI commands are sent to the MST 488-27 controller as output strings within the selected programming language (PASCAL, BASIC, etc.) in accordance with the manufacturer's requirements for the particular GPIB interface card used.

Different programming languages (e.g., BASIC, C, PASCAL, etc.) have different ways of representing data that is to be put on the IEEE 488 bus. It is up to the programmer to determine how to output the character sequence required for the programming language used. Address information (GPIB address) must be included before the command sequence. (See PAR. 2.2.1 to establish the MST 488-27 controller GPIB address.)

NOTE: Although some basic information is provided, the procedures in this manual assume that programming of the unit using SCPI commands will be done by personnel who are experienced programmers and understand the protocols required by SCPI and IEEE 488.2.

3.4.1 SCPI MESSAGES

There are two kinds of SCPI messages: program messages from controller to power supply, and response messages from the power supply to the controller. Program messages consist of one or more properly formatted commands/queries and instruct the power supply to perform an action; the controller may send a program message at any time. Response messages consist of formatted data; the data can contain information regarding operating parameters, power supply state, status, or error conditions.

3.4.2 COMMON COMMANDS/QUERIES

Common commands and queries are defined by the IEEE 488.2 standard to perform overall power supply functions (such as identification, status, or synchronization) unrelated to specific power supply operation (such as setting voltage/current). Common commands and queries are preceded by an asterisk (*) and are defined and explained in Appendix A (see Table 3-4). Refer also to syntax considerations (PARs 3.4.3 through 3.4.6).

3.4.3 SCPI SUBSYSTEM COMMAND/QUERY STRUCTURE

Subsystem commands/queries are related to specific power supply functions (such as setting output voltage, current limit, etc.) Figure 3-2 is a tree diagram illustrating the structure of SCPI subsystem commands used in the MST 488-27 controller with the "root" at the left side, and specific commands forming the branches. The subsystem commands are defined and explained in Appendix B (see Table 3-4).

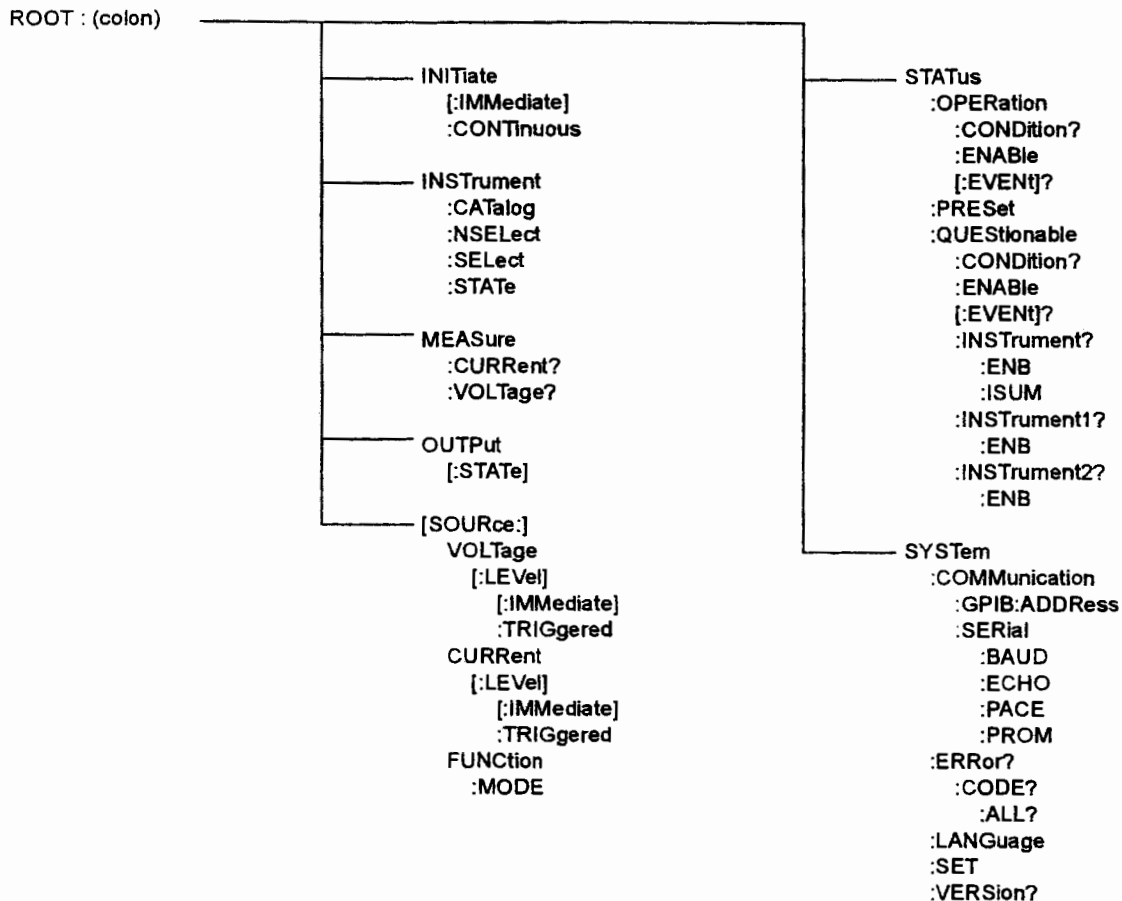

FIGURE 3-2. TREE DIAGRAM OF SCPI COMMANDS USED WITH MST 488-27 CONTROLLER

3.4.4 PROGRAM MESSAGE STRUCTURE

SCPI program messages consist of one or more *message units* ending with a *terminator*. The terminator is not part of the syntax; it is defined by the way your programming language indicates the end of a line. The message unit is a keyword consisting of a single command or query word followed by a terminator (e.g., CURR?<newline> or TRIG<end-of-line>). The message unit may include a data parameter after the keyword separated by a space; the parameter is usually numeric (e.g., CURR 5<newline>), but may also be a string (e.g., OUTP ON<newline>). Figure 3-3 illustrates the message structure, showing how message units are combined. The following subparagraphs explain each component of the message structure.

NOTE: An alternative to using the message structure for multiple messages defined in the following paragraphs is to send each command as a separate line. In this case each command must use the full syntax shown in Appendix B.

TABLE 3-4. SCPI COMMAND INDEX

COMMAND	PAR. REFERENCE	COMMAND	PAR. REFERENCE	COMMAND	PAR. REFERENCE
*CLS	A.2	MEAS:CURRE?	B.10	STAT:QUES:ENAB	B.30
*ESE	A.3	MEAS:VOLT?	B.11	STAT:QUES:ENAB?	B.31
*ESE?	A.4	OUTP:[STAT]	B.12	STAT:QUES:INST?	B.32
*ESR?	A.5	OUTP:[STAT]?	B.13	STAT:QUES:INST1?	B.33
*IDN?	A.6	[SOUR]:CURR	B.14	STAT:QUES:INST2?	B.34
*OPC	A.7	[SOUR]:CURR?	B.15	STAT:QUES:INST:ENAB, ?	B.35, B.36
OPC?	A.8	[SOUR]:CURR:TRIG	B.16	STAT:QUES:INST1:ENAB, ?	B.37, B.38
*RST	A.10	[SOUR]:CURR:TRIG?	B.17	STAT:QUES:INST2:ENAB, ?	B.39, B.40
*SRE	A.11	[SOUR]:VOLT	B.18	STAT:QUES:INST:ISUM?	B.41
*SRE?	A.12	[SOUR]:VOLT?	B.19	STAT:QUES:INST:ISUM:ENAB, ?	B.42, B.43
*STB?	A.13	[SOUR]:VOLT:TRIG	B.20	SYST:COMM:GPIB:ADDR	B.44
*TRG	A.14	[SOUR]:VOLT:TRIG?	B.21	SYST:COMM:SER:BAUD	B.45
*TST	A.15	[SOUR]:FUNC:MODE	B.22	SYST:COMM:SER:ECHO	B.46
*WAI	A.16	STAT:OPER:COND?	B.23	SYST:COMM:SER:PACE	B.47
INIT[:IMM]	B.2	STAT:OPER:ENAB	B.24	SYST:COMM:SER:PROM	B.48
INIT:CONT	B.3	STAT:OPER:ENAB?	B.25	SYST:ERR	B.49
INIT:CONT?	B.4	STAT:OPER?	B.26	SYST:LANG	B.50
INST:CAT	B.5	STAT:PRES	B.27	SYST:SET	B.51
INST, INST?	B.6, B.7, B.8	STAT:QUES?	B.28	SYST:VERS?	B.52
INST:STAT	B.9	STAT:QUES:COND?	B.29		

3.4.4.1 KEYWORD

Keywords are instructions recognized by a decoder within the MST 488-27 controller, referred to as a "parser." Each keyword describes a command function; all keywords used by the MST 488-27 controller are listed in Figure 3-2.

Each keyword has a long form and a short form. For the long form the word is spelled out completely (e.g. STATUS, OUTPUT, VOLTAGE, and TRIGGER are long form keywords). For the short form only the first three or four letters of the long form are used (e.g., STAT, VOLT, OUTP, and TRIG). The rules governing short form keywords are presented in Table 3-5.

You must use the rules described in Table 3-5 when using keywords. Using an arbitrary short form such as ENABL for ENAB (ENABLE) or IMME for IMM (IMMEDIATE) will result in an error. Regardless of which form chosen, you must include all the letters required by that form.

To identify the short form and long form in this manual, keywords are written in upper case letters to represent the short form, followed by lower case letters indicating the long form (e.g., IMMEDIATE, EVENT, and OUTPUT). The parser, however, is not sensitive to case (e.g., outp, OutP, OUTPUT, ouTPut, ouTPut, or OUTp are all valid).

TABLE 3-5. RULES GOVERNING SHORTFORM KEYWORDS

IF NUMBER OF LETTERS IN LONGFORM KEYWORD IS:	AND FOURTH LETTER IS A VOWEL?	THEN SHORT FORM CONSISTS OF:	EXAMPLES
4 OR FEWER	(DOES NOT MATTER)	ALL LONG FORM LETTERS	MODE
5 OR MORE	NO	THE FIRST FOUR LONG FORM LETTERS	MEASure, OUTPut, EVENt
	YES	THE FIRST THREE LONG FORM LETTERS	LEVel, IMMEDIATE, ERRor

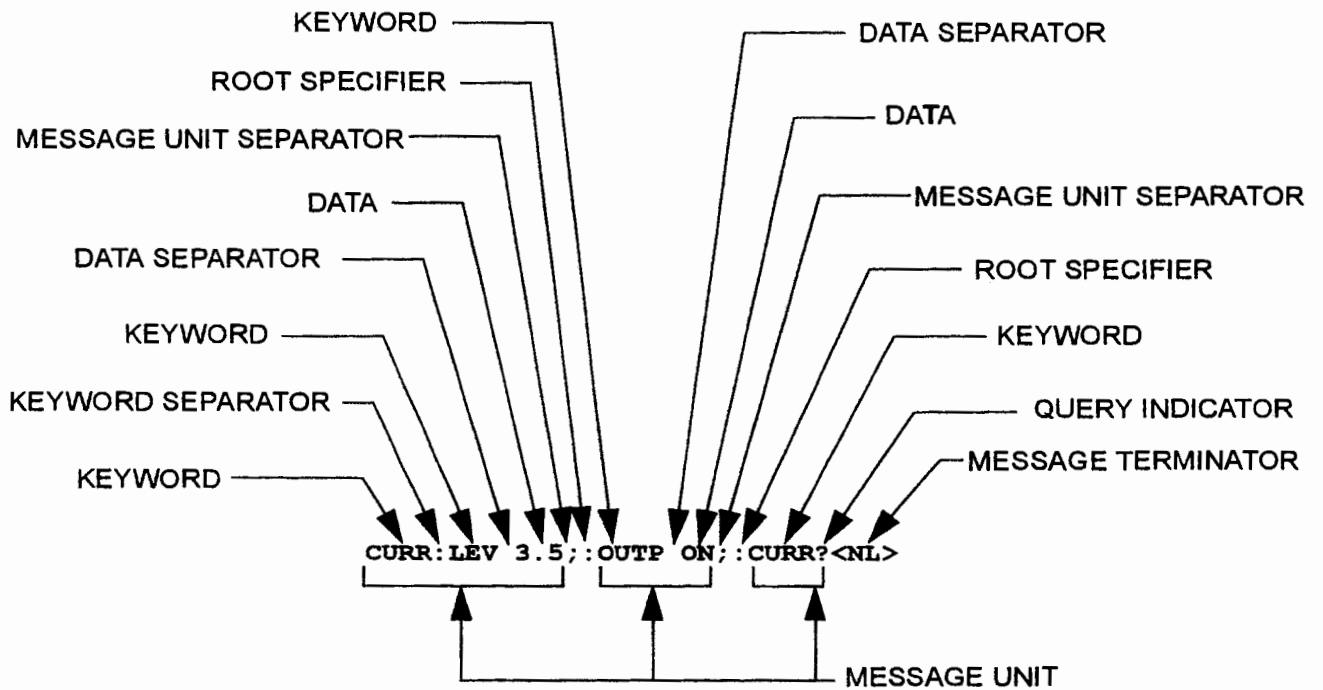

FIGURE 3-3. MESSAGE STRUCTURE

3.4.4.2 KEYWORD SEPARATOR

If a command has two or more keywords, adjacent keywords must be separated by a colon (:) which acts as the keyword separator (e.g., CURR:LEV:TRIG). The colon can also act as a root specifier (paragraph 3.4.4.7).

3.4.4.3 QUERY INDICATOR

The question mark (?) following a keyword is a query indicator. This changes the command into a query. If there is more than one keyword in the command, the query indicator follows the last keyword. (e.g., VOLT? and MEAS:CURR?).

3.4.4.4 DATA

Some commands require data to accompany the keyword either in the form of a numeric value or character string. Data always follows the last keyword of a command or query (e.g., VOLT:LEV:TRIG 14 or SOUR:VOLT? MAX).

Some data is required to be boolean. Boolean data represents either an on or off condition. The MST 488-27 accepts either ON or 1 for the true (on) state and either OFF or 0 for the false (off) state (e.g. OUTPUT OFF is the same as OUTPUT 0).

3.4.4.5 DATA SEPARATOR

Data must be separated from the last keyword by a space (e.g., VOLT:LEV:TRIG 14 or SOUR:VOLT? MAX).

3.4.4.6 MESSAGE UNIT SEPARATOR

When two or more message units are combined in a program message, they must be separated by a semicolon (;) (e.g., VOLT 15;MEAS:VOLT? and CURR 12; CURR:TRIG 12.5).

3.4.4.7 ROOT SPECIFIER

The root specifier is a colon (:) that precedes the first keyword of a program message. This places the parser at the root (top left, Figure 3-2) of the command tree. Note the difference between using the colon as a keyword separator and a root specifier in the following examples:

VOLT:LEV:IMM 16 Both colons are keyword separators.

:CURR:LEV:IMM 4 The first colon is the root specifier, the other two are keyword separators.

VOLT:LEV 6::CURR:LEV 15 The second colon is the root specifier, the first and third are keyword separators.

:INIT ON::TRIG::MEAS:CURR?:VOLT? The first three colons are root specifiers.

3.4.5 ADDRESSING MULTIPLE POWER SUPPLIES

Power supplies on the IEEE 1118 bus are selected by node address, also referred to as node number or channel number. Refer to the applicable manuals for the power modules connected to the IEEE 1118 bus to set each power module to a unique node number, from 1 to 31 (a maximum of 27 power modules may be connected to the bus).

The node number may follow any part of a SCPI command. Note that there must be no space preceding the node number.

e.g., `meas2:volt?` or `meas:volt2?` both measure output voltage of the power supply at node number 2.

e.g., `func3:mode volt` or `func:mode3 volt` both set the power supply at node number 3 to commanded voltage mode.

e.g., `stat1:ques?` or `stat:ques1?` or `stat:ques:cond1?` all read Questionable Register status of the power supply at node number 1.

Upon power turn-on, commands sent without a node (channel) number will go to the default node address (1) until another node number is specified. Once another node number is specified, the new number becomes the default until another is specified.

NOTE: An alternate means of selecting the node, is to use IEEE 488 secondary addressing, where the secondary address is the power supply node address (refer to PAR. 2.2.2 to enable this feature).

The node selected can also be changed using the `INSTrument:SElect <N>` command. This allows subsequent commands to operate on the specified node (e.g. `INST:SEL 10` causes node 10 to be selected).

3.4.6 UNDERSTANDING THE COMMAND STRUCTURE

Understanding the command structure requires an understanding of the subsystem command tree illustrated in Figure 3-2. The “root” is located at the top left corner of the diagram. The parser goes to the root if:

- a message terminator is recognized by the parser
- a root specifier is recognized by the parser

Optional keywords are enclosed in brackets [] for identification; optional keywords can be omitted and the power supply will respond as if they were included in the message. The root level keyword [SOURCE] is an optional keyword. Starting at the root, there are various branches or paths corresponding to the subsystems. The root keywords for the MST 488-27 controller are :INITiate, :MEASure, :OUTPut, [:SOURce], :STATus, and :SYSTem. Because the [SOURCE] keyword is optional, the parser moves the path to the next level, so that VOLTage, CURRent, and FUNction commands are at the root level.

Each time the parser encounters a keyword separator, the parser moves to the next indented level of the tree diagram. As an example, the STATus branch is a root level branch that has three sub-branches: OPERation, PRESet, and QUEStionable. The following illustrates how SCPI code is interpreted by the parser:

STAT:PRES<NL>

The parser returns to the root due to the message terminator.

STAT:OPER?;PRES<NL>

The parser moves one level in from STAT. The next command is expected at the level defined by the colon in front of OPER?. Thus you can combine the following message units STAT:OPER? and STAT:PRES;

STAT:OPER:COND?;ENAB 16<NL>

After the OPER:COND? message unit, the parser moves in one level from OPER, allowing the abbreviated notation for STAT:OPER:ENAB.

3.4.7 PROGRAM MESSAGE SYNTAX SUMMARY

- Common commands begin with an asterisk (*).
- Queries end with a question mark (?).
- Program messages consist of a root keyword and, in some cases, one or more message units separated by a colon (:) followed by a message terminator. Several message units of a program message may be separated by a semicolon (;) without repeating the root keyword.
- If a program message has more than one message unit, then a colon (:) must precede the next keyword in order to set the parser back to the root (otherwise the next keyword will be taken as a subunit of the previous message unit).

e.g., the command `meas:volt?;curr?` will read output voltage and output current since both `volt?` and `curr?` are interpreted as subunits of the `meas` command.

- Several commands may be sent as one message; a line feed terminates the message. Commands sent together are separated by a semicolon (;). The first command in a message starts at the root, therefore a colon (:) at the beginning is not mandatory.

e.g., the command `meas:volt?;:curr?` will read output voltage and programmed current since the colon preceding `curr?` indicates that `curr?` is not part of the `meas` command and starts at the root.

- UPPER case letters in mnemonics are mandatory (short form). Lower case letters may either be omitted, or must be specified completely (long form)
e.g., `INSTrument` (long form) has the same effect as `INST` (short form).
- Commands/queries may be given in upper/lower case (long form)
e.g., `SoUrCe` is allowed.
- Text shown between brackets [] is optional.
e.g., `:[SOUR]VOLT:[LEV] TRIG` has the same effect as `:VOLT TRIG`

3.4.8 STATUS REPORTING

The status reporting of the MST 488-27 follows the SCPI and IEEE 488.2 requirements. The serial poll response of the MST 488-27 provides summary bits of the status and error reporting system. The simplest status report is the command valid reporting and data availability. This successful decoding of a command string generates no error and is indicated by the bit 3 of the serial poll response being a zero. The setting of bit 4 in the status byte indicates data is available to the controller in response a command query message.

3.4.8.1 STATUS REPORTING STRUCTURE

The status reporting of the MST 488-27 uses four status registers, illustrated in Figure 3-4. These registers are the Questionable, Operation, Standard Event and Service Request registers. The Questionable and Operation registers are 16 bit registers and the Standard Event and Service Request registers are 8 bits. These four registers are referred to as condition registers. Each of the four condition registers is associated with two related registers: an event register which holds unlatched events reported in realtime by the instrument and is cleared by reading the register, and an enable register which allows the contents of the event register to be passed through to set the associated condition register.

A zero to one transition of a condition register is added to the event register if the specific bit in the enable register is also a 1. Reading an event register clears all of the bits found in the event register. If any bits are set in an event register, the following condition register bit is then set. For example, if the STAT:QUES:ENB (enable) register has bit 0 set and a voltage error is detected, the event registers bit 0 is set. The 1 in the event register causes bit 3 of the status byte to be asserted. The Service Request register is ANDed with its enable register for all bits except bit 6. The result is placed in bit 6 of the Service Request register. If bit 6 is a 1 (true), it causes the MST 488-27 to assert the SRQ line to the host controller.

Figure 3-4 also shows that if the error/event queue is not empty, bit 3 is set in the Service Request register and bit 4 indicates that a message is available in the output buffer.

3.4.8.2 OPERATIONAL STATUS REGISTER

The OPERational condition register contains conditions which are a part of the instrument's normal operation. The definition of each of these bits (condition register) is as follows:

- 1 through 7 - Not Used — always zero.
- 8 - Constant Voltage — 1 indicates the instrument is in constant voltage mode.
- 9 - Relay — 1 indicates the power supply relay is closed.
- 10 - Constant Current — 1 indicates the instrument is in constant current mode.
- 11 through 15 - Not Used — always zero.

3.4.8.3 QUESTIONABLE STATUS REGISTER

The QUESTionable condition register (see Figure 3-4) contains status bits representing data/signals which give an indication of the quality of various aspects of the signal.

A bit set in the QUESTionable condition register indicates that the data currently being acquired or generated is of questionable quality due to some condition affecting the parameter associated with that bit.

- 8 - Voltage Mode — 1 indicates the instrument is in Voltage mode.
- 9 - Relay — 1 indicates the power supply relay is closed, unit is supplying power at output terminals.
- 10 - Current Mode — 1 indicates the Power Supply is in Current mode. Changes in this bit do not affect the event register.
- 14 - Command warning — This bit indicates a non-fatal warning that relates to the instrument's interpretation of a command, query, or on or more parameters of a specific command or query. The power supply sets this bit for
 - MEAS:VOLT? 10,1 — The 10 is the number of digits and the 1 is the range. Since this capability is not implemented in Kepco power supplies, the Command Warning bit is set.
 - INST:SEL 2 sent to a single power supply. Trying to select unit 2 when only one power supply is connected causes the Command Warning bit to be set.

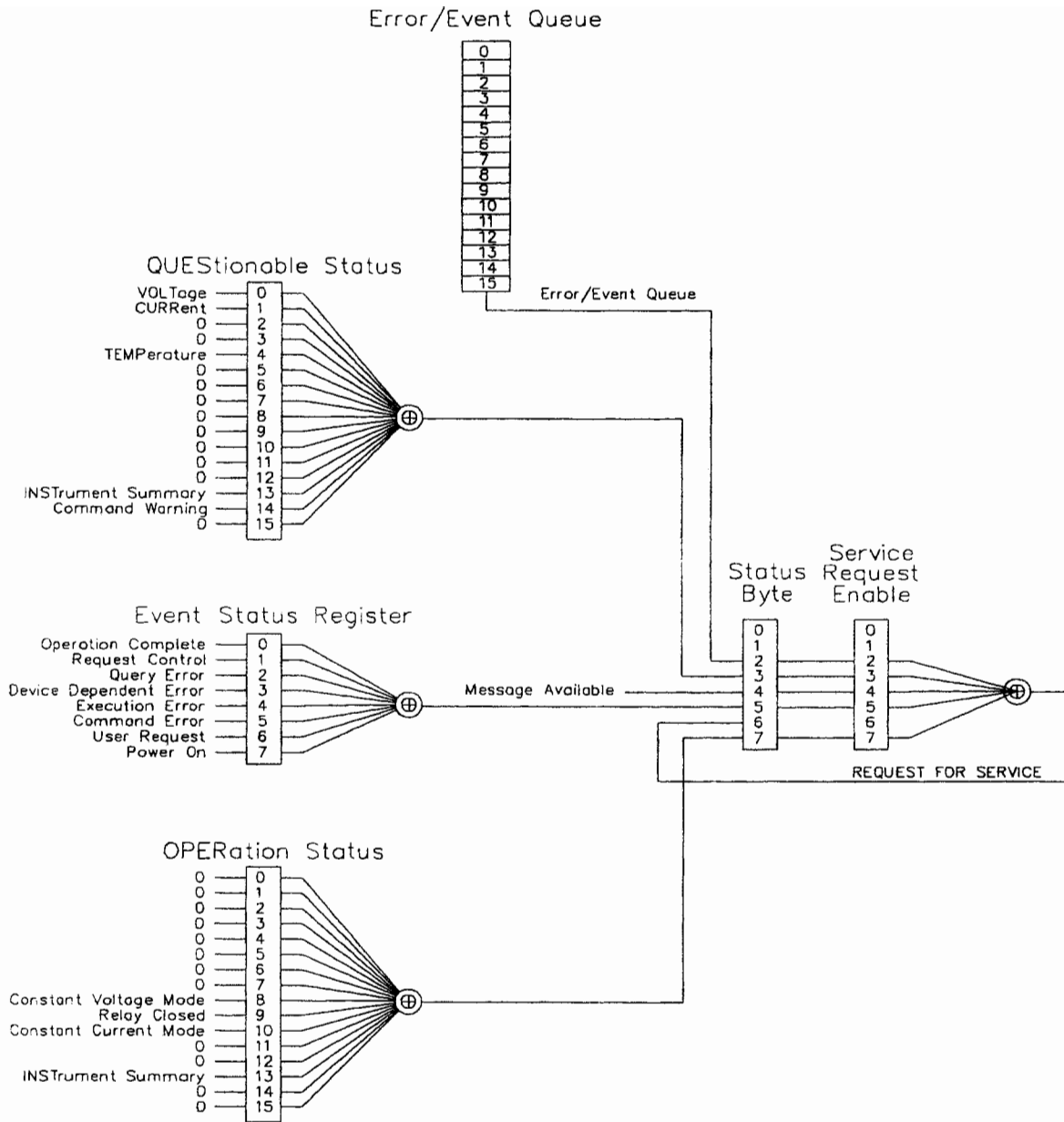

3041682

FIGURE 3-4. STATUS REPORTING STRUCTURE

3.4.8.4 MULTIPLE LOGICAL INSTRUMENTS

The MST 488-27 is a SCPI device that supports multiple logical instruments; it allows a choice between two methods of status reporting. The status reporting default upon powerup treats the unit as a single channel instrument. When multiple channels are in use, a SCPI compliant status structure can be selected which provides an INSTRument summary status register and an individual instrument ISUMmary for each logical instrument. These registers are equivalent to the Status Questionable register of a single channel instrument and are also found in the STATUS

Questionable register for the selected channel. The contents of the STATUS Questionable register can also contain the summary of all instruments as shown in Figure 3-5.

The selection of the status reporting structure is controlled by the `SYSTEM:SET SI` (Instrument Structure) command, either `SI0` (off) or `SI1` (on). The power-up default is the off condition. To enable the SCPI compliant mode of operation for multiple logical instruments the user must send `SYSTEM:SET SI1` to the MST 488-27 during initialization. The `SI1` state is not remembered when the unit is turned off. To return to the standard method of reporting the selected device's status without turning the unit off, send `SYSTEM:SET SI0`. The state of the power supply upon power up for language (SCPI/CIL), compatibility and GPIB addressing is selected by DIP switches P1 and P2 (see PAR. 2.2.2 and Table 2-2).

When the MST 488-27 is set up for SCPI compliant status reporting for multiple channels, the specific instrument's Questionable register is found in the `STAT:QUES:INST:ISUM<n>` register. This register has the same bit structure as the single channel Questionable register. The ISUM enable register is ANDed with the bits of the channel's ISUM register and its bit is placed in the INST register. The Questionable register bits are the logical ORing of all channels' Questionable ISUM register. This is shown in figure 3-5.

The ISUMmary registers set the INSTRument register, which in turn sets bit 13 of the QUESTIONable or OPERAtion status register. This is shown pictorially in Figure 3-5.

The `STATUS:QUESTIONABLE` and `STATUS:QUESTIONABLE:CONDITION` registers are the same in this mode of status reporting. The condition register indicates the status of the various event registers and bits set are only cleared if the source of the bit is cleared.

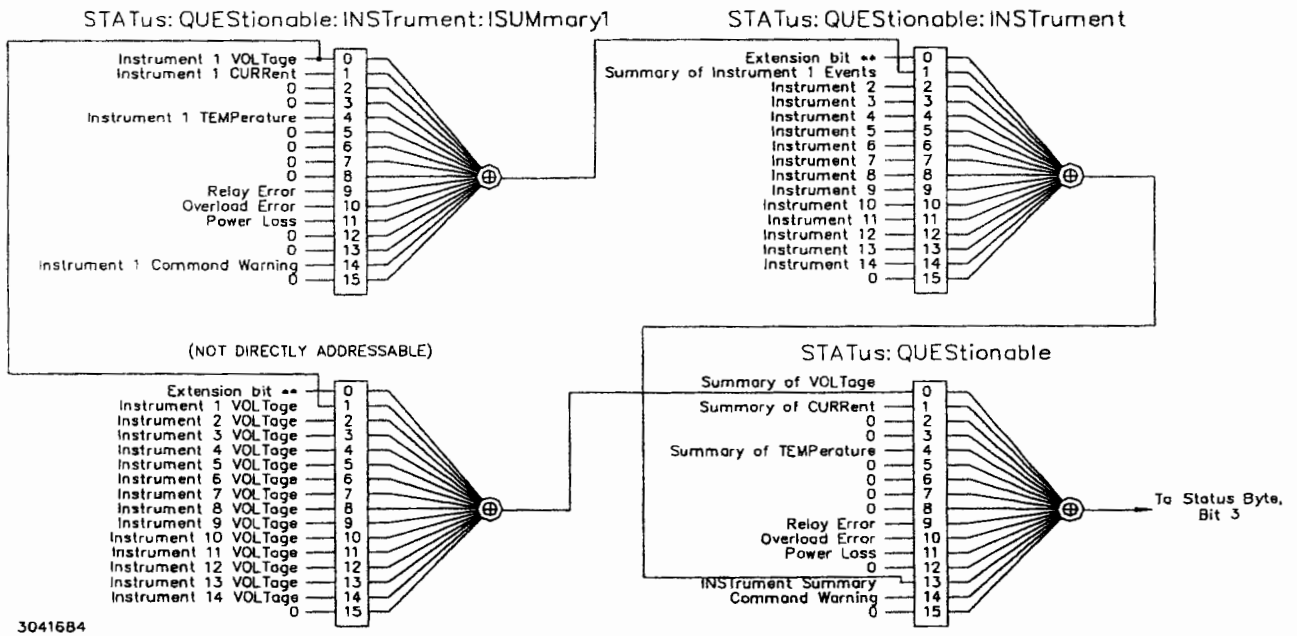

FIGURE 3-5. EXPANSION OF QUESTIONABLE REGISTER FOR MULTIPLE LOGICAL INSTRUMENTS

3.4.9 SCPI PROGRAM EXAMPLE

Figure 3-6 is an example of a program using SCPI commands to program an MST Power Supply. The program illustrated is for a configuration using an IBM PC or compatible with a National Instruments GPIB interface card. (It will be necessary to consult the manufacturer's data to achieve comparable functions with an interface card from a different manufacturer.) This program sets output voltage (Voltage mode) or voltage limit (Current mode) to 5V, and current limit (Voltage mode) or output current (Current mode) to 1A, then reads the measured (actual) voltage and current, then prints the measurements.

```
/* **** */
/* Sample Program For KEPCO power supply, using National Instruments */
/* GPIB interface card and IBM PC or compatible computer */
/* **** */

#include <stdio.h>
#include "decl.h"

char rd_str[80];           // Input buffer
char dat_str[80];        // Output buffer
int  bd,adr;

main() {
    adr = ibfind("DEV6"); // Open DEV6 (defined by IBCONF)
    bd = ibfind ("GPIB0"); // Open GPIB card
    ibsic (bd);           // Send Interface Clear
    ibsre (bd,1);        // Set remote line true

    strcpy(dat_str,"VOLT 5;CURR 1"); // Define a set command
    strcat (dat_str,"\r\n");        // Append delimiter
    ibwrt (adr,dat_str,strlen(dat_str)); // Send string to power supply

    strcpy(dat_str,"MEAS:VOLT?;CURR?"); // Define a measure command
    strcat (dat_str,"\r\n");        // Append delimiter
    ibwrt (adr,dat_str,strlen(dat_str)); // Send string to power supply

    strset(rd_str,'\0'); // Clear input buffer
    ibrd(adr,rd_str,64); // Read result of measure
    printf("received : %s\n",rd_str); // Print voltage and current
}

```

FIGURE 3-6. TYPICAL EXAMPLE OF MST 488-27 CONTROLLER PROGRAM USING SCPI COMMANDS

3.5 CIIL PROGRAMMING

The CIIL command language is used on early models of Kepco power supplies and controllers. The command functions are included here for compatibility with other equipment programmed with CIIL commands. The CIIL command set for the MST 488-27 Controller is defined and explained in Appendix C.

APPENDIX A - IEEE 488.2 COMMAND/QUERY DEFINITIONS

A.1 INTRODUCTION

This appendix defines the IEEE 488.2 common commands and queries used with the MST 488-27 Controller. Common commands and queries are preceded by an asterisk (*) and are defined and explained in Figures A-1 through A-14, arranged in alphabetical order. Table A-1 provides a quick reference of all IEEE 488.2 common commands and queries used in the MST 488-27 Controller.

TABLE A-1. IEEE 488.2 COMMAND/QUERY INDEX

COMMAND	PAR.	COMMAND	PAR.
*CLS	A.2	*RST	A.10
*ESE, ?	A.3, A.4	*SRE, ?	A.11, A.12
*ESR?	A.5	*STB?	A.13
*IDN?	A.6	*TRG	A.14
*OPC, ?	A.7, A.8	*TST?	A.15
*OPT	A.9	*WAI	A.16

A.2 *CLS — CLEAR STATUS COMMAND

***CLS**

Syntax: *CLS

Description: **Clears status data.** Clears the error queue of the instrument. It also clears the following registers without affecting the corresponding Enable Registers: Standard Event Status Register (ESR), Operation Status Event Register, Questionable Status Event Register, and Status Byte Register (STB).
 Related commands: *OPC *OPC?. (See example, Figure A-1.)

A.3 *ESE — STANDARD EVENT STATUS ENABLE COMMAND

***ESE**

Syntax: *ESE <integer> where <integer> = positive whole number: 0 to 255 per Table A-2.
 Default Value: 0

Description: **This command programs the standard Event Status Enable register bits.** The contents function as a mask to determine which events of the Event Status Register (ESR) are allowed to set the ESB (Event Summary Bit) of the Status Byte Register. Enables the Standard events to be summarized in the Status Byte register (1 = set = enable function, 0 = reset = disable function). All of the enabled events of the standard Event Status Enable register are logically ORed to cause ESB (bit 5) of the Status Byte Register to be set (1 = set = enable, 0 = reset = disable). (See example, Figure A-1.)

TABLE A-2. STANDARD EVENT STATUS ENABLE REGISTER AND STANDARD EVENT STATUS REGISTER BITS

CONDITION	PON	NU	CME	EXE	DDE	QUE	NU	OPC
BIT	7	6	5	4	3	2	1	0
VALUE	128	64	32	16	8	4	2	1

PON Power On
 NU (Not Used)
 CME Command Error
 EXE Execution Error
 DDE Device Dependent Error
 QUE Query Error
 OPC Operation Complete

A.4 *ESE? — STANDARD EVENT STATUS ENABLE QUERY

*ESE?

Syntax: *ESE? Return value: Integer> value per Table A-2.

Description: **Returns the mask stored in the Standard Event Status Enable Register.** Contents of Standard Event Status Enable register (*ESE) determine which bits of Standard Event Status register (*ESR) are enabled, allowing them to be summarized in the Status Byte register (*STB). All of the enabled events of the Standard Event Status Enable Register are logically ORed to cause ESB (bit 5) of the Status Byte Register to be set (1 = set = enable function, 0 = reset = disable function). (See example, Figure A-1.)

A.5 *ESR? — EVENT STATUS REGISTER QUERY

*ESR?

Syntax: *ESR?
Return value: <integer> (Value = contents of Event Status register as defined in Table A-2.)

Description: **Causes the power supply to return the contents of the Standard Event Status register. After it has been read, the register is cleared.** The Standard Event Status register bit configuration is defined in Table A-2 (1 = set, 0 = reset). The error bits listed in Table A-2 are also related to error codes produced during parsing of messages and to errors in the power supply.

- Any 1xx type error sets the Command error bit (5).
- Any 2xx type error sets the Execution error bit (4).
- Any 3xx type error sets the Device error bit (3). The Device error bit will be set when Current Error or Voltage Error is detected and the corresponding Status Questionable bit is set (see PAR. B.28).
- Any 4xx type error sets the Query error bit (2).

Related Commands: *CLS, *ESE, *OPC. (See example, Figure A-1.)

A.6 *IDN? — IDENTIFICATION QUERY

*IDN?

Syntax: *IDN?
Return value: Character string

Description: **Identifies the instrument.** This query requests identification. The string contains the manufacturer name, model, SN, firmware revs. The SN field is normally used for the serial #, but since serial #s are not stored in memory, the channel # is given instead. The firmware revision consists of the controller rev. and power module rev. separated by a '.'. If no module is present at the selected channel, PSC (Power Supply Controller) is given as the model. Supported models include MAT, MBT, and MST. The character string contains the following fields: <Manufacturer>, <Model>, <Serial Number>, <Firmware revision> where: <Manufacturer> = KEPCO, <Model> = MST 488-27, <Serial Number> = MM,DD,YY-SSS (MM - month, DD - day, YY - year, SSS - serial number in that day) <Firmware revision>=n.m (n.m revision, e.g. 1.0) (See example, Figure A-1.)

A.7 *OPC — OPERATION COMPLETE COMMAND

*OPC

Syntax: *OPC

Description: **Causes power supply to set status bit 0 (Operation Complete) when pending operations are complete.** This command sets Standard Event Status Register bit 0 (see Table A-2) to "1" when all previous commands have been executed and changes in output level have been completed. This command does not prevent processing of subsequent commands, but bit 0 will not be set until all pending operations are completed. (1 = set = enable function, 0 = reset = disable function). (See example, Figure A-1.) As an example, the controller sends command(s), then sends *OPC. If controller then sends *ESR?, the power supply responds with either a "0" (if the power supply is busy executing the programmed commands), or a "1" (if the previously programmed commands are complete). (See example, Figure A-1.)

A.8 *OPC? — OPERATION COMPLETE QUERY

*OPC?

Syntax: *OPC?

Return value: <1> (ASCII) placed in output queue when power supply has completed operation.

Description: **Indicates when pending operations have been completed.** When all pending operations are complete (all previous commands have been executed and changes in output level have been completed) a "1" is placed in the Output Queue. Subsequent commands are inhibited until the pending operations are completed. *OPC? is intended to be used at the end of a command line so that the application program can monitor the bus for data until it receives the "1" from the power supply Output Queue. (See example, Figure A-1.)

A.9 *OPT? — OPTIONS QUERY

*OPT?

Syntax: *OPT?

Returns string determined by power supply model.

Description: **Causes the power supply to return an ASCII string which defines the functionality of the power supply.** The functionality is defined as follows:

STRING DATA	MEANING
CAL	Support for CALibrate is present.
RL3	Hardware switch controlling remote/local is functional. Unit can be used to take measurements in local mode, but all other functions require the unit to be in remote mode (REN must be asserted).

*CLS	Power supply clears status data.
*ESE 60	Power supply enables bits 5, 4, 3 and 2, allowing command error, execution error, device dependent error and query error to set the Event Status Summary bit when an STB command is executed.
*ESE?	Returns 60, (value of the mask) verifying that bits 5, 4, 3 and 2 are enabled.
*ES	Unknown command will set command error (Bit 5).
*ESR?	Returns 32 (bit 5 set), indicating Command Error has occurred since the last time the register was read.
*IDN?	Controller returns character string: "KEPCO,MST,1,V3.0-3.0"
*OPC	Allows status bit 0 to be set when pending operations complete
VOLT 21;CURR 3	Sets output voltage to 21V, output current to 3A
*ESR	Returns 129 (128 + 1, power on, bit 7 = 1, operation complete, bit 1 = 1)
*ESR	Returns 0 (event status register cleared by prior *ESR?)
VOLT 15;CURR 5;*OPC?	Sets output voltage to 15V, output current to 5A, puts "1" on output bus when command operations are complete.
*RST	Power supply reset to power on default state.
*SRE 40	When ESB or QUES bits are set (Table A-3), the Request for Service bit will be set.
*SRE?	Returns the value of the mask (40).
*STB?	For example, the Power supply responds with 96 (64 + 32) if MSS and the Event Status Byte (Table A-3) summary bit have been set. The power supply returns 00 if no bits have been set.
VOLT 25	Power supply voltage commanded to 25V.
VOLT:TRIG 12	Programs power supply voltage to 12V when *TRG received.
INIT	Trigger event is initialized.
*TRG	Power supply reverts to commanded output voltage of 12V.
*TST?	Power supply executes self test and responds with 0 if test completed successfully, with 1 if test failed.

FIGURE A-1. GPIB COMMANDS

A.10 *RST — RESET COMMAND

***RST**

Syntax: *RST

Description: **Resets power supply to the power on default state.** The power supply is programmed to the power on values of the following parameters: CURR[:LEV][:IMM] = 0, VOLT[:LEV][:IMM] = 0, OUTP[:STAT] = OFF. If the power supply is in either an overvoltage or overcurrent state, this condition is reset by *RST. (See example, Figure A-1.)

A.11 *SRE — SERVICE REQUEST ENABLE COMMAND

***SRE**

Syntax: *SRE<integer> where <integer> = value from 0 - 255 per Table A-3, except bit 6 cannot be programmed.

Description: **Sets the condition of the Service Request Enable register.** The Service Request Enable register determines which events of the Status Byte Register are summed into the MSS (Master Status Summary) and RQS (Request for Service) bits. RQS is the service request bit that is cleared by a serial poll, while MSS is not cleared when read. A "1" (1 = set = enable, 0 = reset = disable) in any Service Request Enable register bit position enables the corresponding Status Byte bit to set the RQS and MSS bits. All the enabled Service Request Enable register bits then are logically ORed to cause Bit 6 of the Status Byte Register (MSS/RQS) to be set. Related Commands: *SRE?, *STB?. (See example, Figure A-1.)

TABLE A-3. SERVICE REQUEST ENABLE AND STATUS BYTE REGISTER BITS

CONDITION	OPER	MSS RQS	ESB	MAV	QUES	ERR QUE	NU	NU
BIT	7	6	5	4	3	2	1	0
VALUE	128	64	32	16	8	4	2	1

OPER Operation Status Summary
MSS Master Status Summary
RQS Request for Service
ESB Event Status Byte summary
MAV Message available
QUES QUESTIONable Status Summary
ERR QUE 1 or more errors occurred (see PAR. B.49)
NU (Not Used)

A.12 *SRE? — SERVICE REQUEST ENABLE QUERY

***SRE?**

Syntax: *SRE? Response: <integer> = value from 0 - 255 per Table A-3.

Description: **Reads the Service Enable Register.** Used to determine which events of the Status Byte Register are programmed to cause the power supply to generate a service request (1 = set = function enabled, 0 = reset = function disabled). Related Commands: *SRE, *STB?. (See example, Figure A-1.)

A.13 *STB? — STATUS BYTE REGISTER QUERY

***STB?**

Syntax: *STB? Response: <integer> value from 0 to 255 per Table A-3.

Description: **Reads Status Byte Register without clearing it.** This Query reads the Status Byte Register (bit 6 = MSS) without clearing it (1 = set = function enabled, 0 = reset = function disabled). The register is cleared only when subsequent action clears all set bits. MSS is set when the power supply has one or more reasons for requesting service. (A serial poll also reads the Status Byte Register, except that bit 6 = RQS, not MSS; and RQS will be reset.) Related Commands: *SRE, *SRE?. (See example, Figure A-1.)

A.14 *TRG — TRIGGER COMMAND

***TRG**

Syntax: *TRG

Description: **Triggers the power supply to be commanded to preprogrammed values of output current and voltage.** When the trigger is armed (checked by examining WTG bit in Status Operational Condition register) *TRG generates a trigger signal. The trigger will change the output of the power supply to the output voltage and current levels specified by VOLT:TRIG and CURR:TRIG commands and clear the WTG bit in the Status Operation Condition register. If INIT:CONT has been issued, the trigger subsystem is immediately rearmed for subsequent triggers, and the WTG bit is again set to 1. *TRG or GET are both addressed commands (only devices selected as listeners will exe-

cute the command). Related Commands: ABOR, INIT, TRIG, CURR:TRIG, VOLT:TRIG. (See example, Figure A-1.)

A.15 *TST? — SELF TEST QUERY

*TST?

Syntax: *TST? Returned value: 0 or 1 (0 = pass test, 1 = fail test)

Description: **Power Supply test.** This query causes the power supply to do a self test and provide the controller with pass/fail results.

A.16 *WAI — WAIT-TO-CONTINUE COMMAND

*WAI?

Syntax: **WAI Returned value: 0 or 1 (0 = pass test, 1 = fail test)

Description: This command can be used to guarantee sequential execution of commands and queries. When all pending operations are complete (all previous commands have been executed, changes in output level have been completed, and no pending trigger operations are set), the WAI command is completed and execution of subsequent commands can continue. *WAI can be aborted only by a GPIB interface Device Clear (DC1).

Example:

Controller sends Command 1	Power supply begins execution of command 1.
Controller sends *WAI	Power supply waits for command 1 to be completed before executing command 2.
Controller sends Command 2	Command 2 executed after command 1 is completed.

Controller sends Command 1	Power supply begins execution of command 1.
Controller sends *WAI	Power supply waits for command 1 to be completed before executing command 2.
Controller sends Command 2	Command 2 executed after command 1 is completed.

FIGURE A-2. USING THE *WAIT-TO-CONTINUE COMMAND

APPENDIX B - SCPI COMMAND/QUERY DEFINITIONS

B.1 INTRODUCTION

This appendix defines the SCPI subsystem commands and queries used with the MST 488-27 Controller. Subsystem commands are defined in PAR. B.2 through B.52, arranged in groups as they appear in the tree diagram, Figure 3-2. Table B-1 provides a quick reference of all SCPI subsystem commands and queries used in the Interface Card.

NOTE: Upon power loss, all programmed values/configurations are lost and must be reprogrammed.

TABLE B-1. SCPI SUBSYSTEM COMMAND/QUERY INDEX

COMMAND	PAR.	COMMAND	PAR.
INIT[:IMM]	B.2	STAT:QUES:COND?	B.29
INIT:CONT, ?	B.3, B.4	STAT:QUES:ENAB, ?	B.30, B.31
INST:CAT?	B.5	STAT:QUES:INST?	B.32
INST:NSEL	B.6	STAT:QUES:INST1?	B.33
INST:SEL	B.7, B.8	STAT:QUES:INST 2?	B.34
INST:STAT	B.9	STAT:QUES:INST:ENAB, ?	B.35, B.36
MEAS:CURR?	B.10	STAT:QUES:INST1:ENAB, ?	B.37, B.38
MEAS:VOLT?	B.11	STAT:QUES:INST2:ENAB, ?	B.39, B.40
OUTP[:STAT], ?	B.12, B.13	STAT:QUES:INST:ISUM?	B.41
[SOUR:]CURR[:LEV][:IMM][:AMP], ?	B.14, B.15	STAT:QUES:INST:ISUM:ENAB, ?	B.42, B.43
[SOUR:]CURR[:LEV]:TRIG[:AMP], ?	B.16, B.17	SYST:COMM:GPIB:ADDR	B.44
[SOUR:]VOLT[:LEV][:IMM][:AMP], ?	B.18, B.19	SYST:COMM:SER:BAUD	B.45
[SOUR:]VOLT[:LEV]:TRIG[:AMP]?	B.20, B.21	SYST:COMM:SER:ECHO	B.46
[SOUR:]FUNC:MODE	B.22	SYST:COMM:SER:PACE	B.47
STAT:OPER:COND?	B.23	SYST:COMM:SER:PROM	B.48
STAT:OPER:ENAB, ?	B.24, B.25	SYST:ERR?	B.49
STAT:OPER[:EVENT]?	B.26	SYST:LANG	B.50
STAT:PRES	B.27	SYST:SET	B.51
STAT:QUES[:EVENT]?	B.28	SYST:VERS?	B.52

B.2 INITiate[:IMMediate] COMMAND

INIT[:IMM]

Syntax: Short Form: INIT[:IMM] Long Form: INITiate[:IMMediate]

Description: **Enables a single trigger.** If INIT:CONT is OFF, then INIT[:IMM] arms the trigger system for a single trigger. If INIT:CONT is ON, then the trigger system is continuously armed and INIT[:IMM] is redundant. This command enables a single trigger. A GPIB <GET>, *TRG or command completes the sequence. Upon receipt of the <GET> or *TRG command, the power supply will return to the programmed values of voltage and current established by the VOLT:TRIG and CURR:TRIG commands. After a GPIB <GET> or *TRG command has been received, subsequent GPIB <GET>, *TRG commands have no effect unless preceded by INIT or INIT:CONT ON. Related Commands: <GET>, *RST, *TRG. (See example, Figure B-2.)

B.3 INITiate:CONTInuous COMMAND

INIT:CONT

Syntax: Short Form: INIT:CONT {ON | OFF} or {1 | 0} (1 = on, 0 = off)
 Long Form: INITiate:CONTInuous {ON | OFF} or {1 | 0} (1 = on, 0 = off)

Description: **INIT:CONT ON enables continuous triggers.; INIT:CONT OFF disables continuous triggers.** If INIT:CONT is OFF, then INIT[:IMM] arms the trigger system for a single trigger. If INIT:CONT is ON, then the trigger system is continuously armed and INIT[:IMM] is redundant. Executing *RST command sets INIT:CONT to OFF. (See example, Figure B-2.)

B.4 INITiate:CONTInuous QUERY

INIT:CONT?

Syntax: Short Form: INIT:CONT? Long Form: :INITiate:CONTInuous?
 Return Value: 1 or 0

Description: **Determines whether continuous triggers are enabled or disabled.** Power supply returns value of INIT:CONT flag: "1" = continuous triggers are enabled (INIT:CONT ON); "0" = continuous triggers disabled (INIT:CONT OFF). (See example, Figure B-2.)

B.5 INSTrument:CATalog QUERY

INST:CAT?

Syntax: Short Form: INST:CAT? Long Form: :INSTrument:CATalog?
 Return Value: comma separated string with the instrument numbers found on the bitbus.

Description: Allows the host computer to determine what instruments are on the bitbus. Unlike the *RST command, this command does not scan possible bitbus addresses to determine if the device is present. The list contains all channel numbers found and allows the host computer to determine if the MST power supplies are connected and powered-up (see Figure B-1).

*RST	Bitbus is scanned and all supplies are set to 0v, 0c, and Voltage mode
INST:CAT?	With three MST's connected to the MST 488 controller the MST 488 returns 1,2,3 if their addresses are set to 1, 2 and 3. *** User turns off supply 2.
INST:CAT?	MST 488 returns 1,3 *** User turns on supply 2
INST:CAT?	MST 488 returns 1,3
INST2	Channel 2 restored
INST:CAT?	MST 488 returns 1,2,3 *** User turns off supply 3
INST:CAT?	MST 488 returns 1,2
VOLT3 4::SYST:ERR?	MST 488 returns "0240, Hardware not found" *** User turns on supply 3
VOLT3 4::SYST:ERR?	Channel 3 restored
INST:CAT?	MST 488 returns 1,2,3

FIGURE B-1. USE OF INSTrument:CATalog QUERY

B.6 INSTrument[:NSElect] COMMAND

INST:NSEL

Syntax: Short Form :INST:NSEL <val> Long Form: INSTrument:NSElect <val>

Description: **Selects power supply connected to channel number <VAL>; also brings off-line or "locked out" power supply to on-line status.** selects the instrument to which subsequent commands will be addressed until another channel is selected. Identical to INST:SEL command (see PAR. B.7).

B.7 INSTrument[:SElect] COMMAND

INST:SEL

Syntax: Short Form :INST:SEL <val> Long Form: INSTrument:SElect <val>

Description: **Selects power supply connected to channel number <VAL>; also brings off-line or “locked out” power supply to on-line status.** selects the instrument to which subsequent commands will be addressed until another channel is selected. The <value> following the command is the channel (node) number, from 1 to 31. This command is also used to bring a power supply on-line (i.e., the controller recognizes a power supply assigned to a selected channel). In cases where a fault has “locked out” a power supply (the controller no longer recognizes the power supply assigned to a channel), this command restores the power supply to the system. (See example, Figure B-4.)

Example: STAT:QUES?2 Program reads the Questionable Event Register for power supply on channel 2.

If the power supply responds with 2048 (bit 11) indicating power loss, the power supply will be off-line and unable to be selected. After the power fault has been corrected, the INST command is sent.

INST2 The power supply on channel 2 is reset and brought on-line; subsequent commands will apply to channel 2 until a new channel is selected.
INST? <Value> 2 returned to controller.

B.8 INSTRUMENT[:SELECT]? QUERY

INST:SEL?

Syntax: Short Form :INST:SEL? Long Form: INSTRUMENT:SELEct ?
Return value: <VAL> 1 to 31

Description: Used to determine which channel selected.

B.9 INSTRUMENT:STATe COMMAND

INST:STAT

Syntax: Short Form :INST:STAT <val> Long Form: INSTRUMENT:STATe <val>

Description: 0 (off) sets output to 0; 1 (on) restores output voltage and current.

B.10 MEASURE[:SCALAR]:CURRENT[:DC]? QUERY

MEAS:CURRE?

Syntax: Short Form: MEAS[:SCAL]:CURRE[:DC]? <boolean>
Long Form: MEASURE[:SCALAR]:CURRENT[:DC]? <boolean>
<boolean> = 0 or 1
Return Value: <num_value> (digits with decimal point and Exponent)

Description: **Measures actual current.** This query returns the actual value of output current (measured at the output terminals) as determined by the programmed value of voltage and current and load conditions. NOTE: The SCPI convention for this command allows the controller to establish the range and accuracy of the measurement if nn,nn is added after the question mark; the power supply accepts this format but sets the command warning bit (13) in the status questionable register and ignores the extra characters. (See example, Figure B-2.)

B.11 MEASURE[:VOLTage][:SCALAR][:DC]? QUERY

MEAS:VOLT?

Syntax: Short Form: MEAS[:SCAL]:VOLT[:DC]? <boolean>
Long Form: MEASURE[:SCALAR]:VOLTage[:DC]? <boolean>
<boolean> = 0 or 1
Return Value: <num_value> (digits with decimal point and Exponent)

Description: **Measures actual voltage.** This query returns the actual value of output voltage (measured at the output terminals) as determined by the programmed value of voltage and current and load conditions. NOTE: The SCPI convention for this command allows the controller to establish the range and accuracy of the measurement if nn,nn is added after the question mark; the power supply accepts this format but sets the command warning bit (13) in the status questionable register and ignores the extra characters. (See example, Figure B-2.)

B.12 OUTPUT[:STATe] COMMAND

OUTP

Syntax: Short Form: OUTP[:STAT] <boolean> Long Form: OUTPUT[:STATe] <boolean>
<boolean>=(0 or OFF, 1 or ON)

Description: **Enables or disables the power supply output.** Upon power up the output is enabled (OUTP ON). When OUTP OFF is executed, the programmed values of voltage and current are saved, then voltage and current are programmed to 0. When OUTP ON is executed, the power supply output is restored to the previously saved programmed values. The saved values of voltage and current can be viewed by VOLT? and CURR? queries. Related Commands: OUTP?. (See example, Figure B-2.)

B.13 OUTPut[:STATe] QUERY

OUTP?

Syntax: Short Form: OUTP[:STAT]? Long Form: OUTPut[:STATe]?
Return Value: <int_value> (0 or 1)

Description: **Indicates whether power supply output is enabled or disabled.** Returns 0 if output disabled, returns 1 if output enabled. Related Commands: OUTP. (See example, Figure B-2.)

NOTE: Power supply assumed to be operating in constant voltage mode.

OUTP ON	Output enabled.
OUTP?	Power supply returns "1" (output enabled).
VOLT 21; CURR 1.5	Power supply output programmed to go to 21V, current limit 1.5A
INIT:CONT ON	Continuous triggers enabled.
INIT:CONT?	Power supply returns "1."
VOLT:TRIG 15;CURR:TRIG 3	Power supply output programmed to return to 15V, current limit 3A upon receipt of trigger.
*TRG	Power supply output returns to 15V,current limit 3A.
VOLT 21; CURR 5E-2	Power supply output programmed to go to 21V, current limit 0.05A
MEAS:VOLT?	If actual value of output voltage is 20.9V, power supply returns 2.09E+1.
MEAS:CURR?	If actual value of output current is 0.0483A, power supply returns 4.83E-2.
FUNC:MODE?	Returns VOLT if power supply operating in constant voltage mode, CURR for constant current mode.
CURR:TRIG?	Returns 3 (current value established by CURR: TRIG.
VOLT:TRIG?	Returns 15 (voltage value established by VOLT:TRIG.
*TRG	Power supply output returns to 21V, current limit 0.05A.
INIT:CONT 0	Triggers disabled.
INIT:CONT?	Power supply returns "0."
OUTP OFF	Output disabled.
OUTP?	Returns 0 (output disabled).
MEAS:VOLT?	Returns 0. (measured output voltage).
VOLT?	Returns 17.(programmed output voltage)/
CURR?	Returns 1.5 (programmed current)
CURR? MAX	Returns 4 (assuming maximum allowable current for power supply being addressed is 4A, i.e. ABC 25-4DM).
CURR? MIN	Returns 0 (minimum allowable current).
CURR?	Returns 1.5, indicating programmed current value = 1.5A.
SYST:VERS?	Returns 1997.0.

FIGURE B-2. PROGRAMMING THE OUTPUT

B.14 [SOURCE:]CURRENT[:LEVEL][:IMMEDIATE][:AMPLITUDE] COMMAND**CURR**

Syntax: Short Form: [SOUR:]CURR[:LEV][:IMM][:AMP] <exp_value>
 Long Form: [SOURCE:]CURRENT[:LEVEL][:IMMEDIATE][:AMPLITUDE] <exp_value>
 <exp_value> = digits with decimal point and Exponent, e.g., 2.71E+1 for 27.1

Description: **Sets programmed current level at power supply output.** This command programs output current to a specific value; actual output current will depend on load conditions. If the value exceeds the maximum for the model being programmed, error message -222, "Data out of range" is posted in output queue. (See example, Figure B-2.)

B.15 [SOURCE:]CURRENT[:LEVEL][:IMMEDIATE][:AMPLITUDE] QUERY**CURR?**

Syntax: Short Form: [SOUR:]CURR[:LEV][:IMM][:AMP]? MIN, MAX
 Long Form: [SOURCE:]CURRENT[:LEVEL][:IMMEDIATE][:AMPLITUDE]? MIN, MAX
 Return Value: <exp_value> = digits with decimal point and Exponent, e.g., 2.71E+1 for 27.1

Description: **Returns either the programmed value, maximum value, or minimum value of current.** The CURR? query returns the programmed value of current. Actual output current will depend on load conditions. The CURR?MAX query returns the maximum current allowed for a particular model. CURR? Returns programmed current value. CURR? MAX returns maximum current allowed for power supply. CURR? MIN returns minimum current allowed for power supply (always 0). Related Commands: CURR. (See example, Figure B-2.)

B.16 [SOURCE:]CURRENT[:LEVEL]TRIGGERED[:AMPLITUDE] COMMAND**CURR:TRIG**

Syntax: Short Form: [SOUR:]CURR[:LEV]:TRIG[:AMP] <exp_value>
 Long Form: [SOURCE:]CURRENT[:LEVEL]:TRIGGERED[:AMPLITUDE] <exp_value>
 <exp_value> = digits with decimal point and Exponent, e.g., 2.71E+1 for 27.1

Description: **Programs current value to be transferred to output by *TRG commands.** Actual output current will depend on load conditions. If the value exceeds the maximum for the model being programmed, error message -222, "Data out of range" is posted in output queue. Related Commands: CURR. (See example, Figure B-2.)

B.17 [SOURCE:]CURRENT[:LEVEL]TRIGGERED[:AMPLITUDE]? QUERY**CURR:TRIG?**

Syntax: Short Form: [SOUR:]CURR[:LEV]:TRIG[:AMP]?
 Long Form: [SOURCE:]CURRENT[:LEVEL]:TRIGGERED[:AMPLITUDE]?
 Return Value: <exp_value> = digits with decimal point and Exponent, e.g., 2.71E+1 for 27.1

Description: **Returns the current value established by CURR:TRIG command.** (See example, Figure B-2.)

NOTE: The power supply is assumed to be operating in constant voltage (cV) mode.	
VOLT 21; CURR 1.1	Power supply programmed to voltage limit 21V, 1.1A.
CURR?	Returns 1.1.
CURR 4.2	Power supply output current programmed to 3.3A, error message -301 posted.
CURR?	Returns 3.3.
	-- OVERCURRENT CONDITION (1 SECOND) OCCURS.
CURR?	Returns small value (approx. 1% of full scale current rating).
CURR 2.5	Power supply output current programmed to 2.5A
	-- OVERCURRENT CONDITION (1 SECOND) OCCURS.
(After 10 seconds)	
CURR?	Returns 2.5.

FIGURE B-3. PROGRAMMING CURRENT

B.18 [SOURCE:]VOLTage[:LEVel][:IMMediate][:AMPlitude] COMMAND**VOLT**

Syntax: Short Form: [SOUR:]VOLT[:LEV][:IMM][:AMP] <exp_value>
 Long Form: [SOURCE:]VOLTage[:LEVel][:IMMediate][:AMPlitude] <exp_value>
 <exp_value> = digits with decimal point and Exponent, e.g., 2.71E+1 for 27.1

Description: **Sets programmed voltage level at power supply output.** This command programs output voltage to a specific value; actual output voltage will depend on load conditions. If the value exceeds the maximum for the model being programmed, error message -222, "Data out of range" is posted in output queue. (See example, Figure B-2.)

B.19 [SOURCE:]VOLTage[:LEVel][:IMMediate][:AMPlitude]? QUERY**VOLT?**

Syntax: Short Form: [SOUR:]VOLT[:LEV][:IMM][:AMP]? {MIN | MAX}
 Long Form: [SOURCE:]VOLTage[:LEVel][:IMMediate][:AMPlitude]? {MIN | MAX}

Description: **Identifies programmed voltage, maximum allowable voltage, or minimum voltage (always 0).** The VOLT? query returns the programmed value of voltage. Actual output voltage will depend on load conditions. The VOLT?MAX query returns the maximum voltage allowed for a particular model (e.g., 25V for MST25-8DM). VOLT?MIN returns minimum voltage allowed for power supply (always 0). Related Commands: VOLT. (See example, Figure B-2)

B.20 [SOURCE:]VOLTage[:LEVel]TRIGgered[:AMPlitude] COMMAND**VOLT:TRIG**

Syntax: Short Form: [SOUR:]VOLT[:LEV]:TRIG[:AMP] <exp_value>
 Long Form: [SOURCE:]VOLTage[:LEVel]:TRIGgered[:AMPlitude] <exp_value>
 <exp_value> = digits with decimal point and Exponent, e.g., 2.71E+1 for 27.1

Description: **Programs voltage value to be transferred to output by *TRG commands.** Actual output voltage will depend on load conditions. If the value exceeds the maximum for the model being programmed, error message -222, "Data out of range" is posted in output queue. (See example, Figure B-2.)

B.21 [SOURCE:]VOLTage[:LEVel]TRIGgered[:AMPlitude]? QUERY**VOLT:TRIG?**

Syntax: Short Form: [SOUR:]VOLT[:LEV]:TRIG[:AMP]?
 Long Form: [SOURCE:]VOLTage[:LEVel]:TRIGgered[:AMPlitude]?
 Return Value: <exp_value> = digits with decimal point and Exponent, e.g., 2.71E+1 for 27.1

Description: **Returns value representing voltage value to be programmed by *TRG command established by VOLT:TRIG command).** (See example, Figure B-2.)

B.22 [SOURCE:]FUNCTION:MODE COMMAND**FUNC:MODE**

Syntax: Short Form: FUNC:MODE {VOLT | CURR}
 Long Form: FUNCTION:MODE {VOLT | CURR}

Description: **Establishes the operating mode of the power supply.** VOLT = Constant Voltage mode (CV).
 CURR = Constant Current mode (CC).

B.23 STATus:OPERation:CONDition QUERY**STAT:OPER:COND?**

Syntax: Short Form: STAT:OPER:COND? Long Form: STATus:OPERation:CONDition?
 Return Value: <int_value> 0 to 1313 (256 + 512 + 1024).

Description: **Returns the value of the Operation Condition Register (see Table B-2).** The Operation Condition Register contains the programmed mode of the power supply (not the actual condition). Bit set to 1 = state enabled (active, true); bit reset to 0 = state disabled (inactive, false). (See example, Figure B-4.)

**TABLE B-2. OPERATION CONDITION REGISTER, OPERATION ENABLE REGISTER,
AND OPERATION EVENT REGISTER BITS**

CONDITION	NU	CC	RLY	CV	NU	NU	NU	NU
BIT	15-11	10	9	8	7-6	5	4-1	0
VALUE	32,768 - 2048	1024	512	256	128 - 64	32	16-2	1

CC - POWER SUPPLY IN CONSTANT CURRENT MODE
 CV - POWER SUPPLY IN CONSTANT VOLTAGE MODE
 NU - NOT USED
 RLY - POWER SUPPLY RELAY IS CLOSED

B.24 STATUS:OPERation:ENABLE COMMAND

STAT:OPER:ENAB

Syntax: Short Form: STAT:OPER:ENAB <int_value> 0 to 32767 (1 + 32 + 256 + 1024)
 Long Form: STATus:OPERation:ENABLE <int_value> 0 to 32767 (1 + 32 + 256 + 1024)

Description: **Sets Operation Enable Register.** The Operation Enable Register is a mask for enabling specific bits in the Operation Event Register which will cause the operation summary bit (bit 7) of the Status Byte register to be set Bit set to 1 = function enabled (active, true); bit reset to 0 = function disabled (inactive, false). The operation summary bit is the logical OR of all the enabled bits in the Operation Event register. (See example, Figure B-4.)

B.25 STATUS:OPERation:ENABLE? QUERY

STAT:OPER:ENAB?

Syntax: Short Form: STAT:OPER:ENAB? Long Form: STATus:OPERation:ENABLE?
 Return Value: <int_value> 0 to 1313 (1 + 32 + 256 + 1024).

Description: **Reads Operation Enable Register (see Table B-2).** Returns value of Operation Enable Register bits. Bit set to 1 = function enabled (active, true); bit reset to 0 = function disabled (inactive, false). (See example, Figure B-4.)

B.26 STATUS:OPERation[:EVENT] QUERY

STAT:OPER?

Syntax: Short Form: STAT:OPER[:EVENT]? Long Form: STATus:OPERation[:EVENT]?
 Return Value: <int_value> 0 to 1313 (1 + 32 + 256 + 1024).

Description: **Indicates changes in conditions monitored by Operational Event Register.** Returns the value of the Operation Event register. The Operation Event register is a read-only register which holds (latches) all events that occur. Reading the Operation Event register clears it. (See example, Figure B-4.)

B.27 STATUS:PRESet COMMAND

STAT:PRES

Syntax: Short Form: STAT:PRES Long Form: STATus:PRESet

Description: **Disables reporting of all status events.** This command sets all bits of the Operation Condition (Table B-2) and Questionable Condition Registers to 0, preventing all status events from being reported. (See example, Figure B-4.)

B.28 STATUS:QUESTIONable[:EVENT]? QUERY

STAT:QUES?

Syntax: Short Form: STAT:QUES[EVENT]? Long Form: STATus:QUESTIONable[EVENT]?
 Return Value: <int_value> actual register value

Description: **Indicates questionable events that occurred since previous STAT:QUES? query.** Returns the value of the Questionable Event register (see Table B-3). The Questionable Event register is a read-only register which holds (latches) all events. Reading the Questionable Event register clears it. (See example, Figure B-4.)

TABLE B-3. QUESTIONABLE EVENT REGISTER, QUESTIONABLE CONDITION REGISTER AND QUESTIONABLE CONDITION ENABLE REGISTER BITS

CONDITION	PL	OL	RE	NU	NU	NU	NU	NU	OT	NU	CE	VE
BIT	11	10	9	8	7	6	5	4	3	2	1	0
VALUE	2048	1024	512	256	128	64	32	16	8	4	2	1

PL POWER LOSS
 OL OVERLOAD
 RE RELAY ERROR
 OT OVERTEMPERATURE
 CE CURRENT ERROR
 VE VOLTAGE ERROR
 NU NOT USED

NOTE: The selected MST power supply is assumed to be operating in cV (constant voltage) mode.

STAT:OPER:ENAB 1056 Mask enabled for CC, WTG and bits.
 STAT:OPER:ENAB? Returns 1056 (32 + 1024) (CC, WTG bits set).
 STAT:QUES:ENAB 3 Mask enabled for OV and OC bits (1 + 2).
 STAT:QUES:ENAB? Returns 3 (1 + 2) indicating OV and OC bits are enabled.
 STAT:PRES Operation Condition and Questionable Condition registers are reset.
 INIT:CONT ON Continuous triggers enabled.
 STAT:OPER:COND? Power supply returns 288 (256 + 32) to indicate that power supply is constant voltage mode and Wait For Trigger is true.
 STAT:OPER? Returns 1057, e.g., indicating that since the last reading of the Operation Event Register the power supply has entered Constant Current mode, the Wait Trigger was set.
 STAT:OPER? Returns 0 indicating no changes since previous reading of the Operation Event register.
 STAT:QUES? Returns 0 (no questionable conditions occurred since previous reading
 --- OVERCURRENT CONDITION OCCURS
 STAT:QUES? Returns 2 (overcurrent protection tripped since the last STAT:QUES? query).
 STAT:QUES:COND? Returns 2, (Power supply still in overcurrent protection state).
 STAT:QUES? Returns 0, (Register cleared by previous STAT:QUES?).
 STAT:QUES:COND? Returns 2, (Power supply still in overcurrent protection state).
 SYST:ERR? Power supply returns 0, "No error" message.
 inst:sel 1 Select instrument 1
 stat:ques? MST 488 responds 4 indicating instrument 1 in current mode
 inst:sel 2 Select instrument 2
 stat:ques? MST 488 responds 8 indicating instrument 2 in voltage mode
 stat:ques:inst:isum1? MST 488 responds 4 indicating instrument 1 in current mode
 stat:ques:inst:isum2? MST 488 responds 8 indicating instrument 2 in voltage mode

FIGURE B-4. USING STATUS COMMANDS AND QUERIES

B.29 STATus:QUESTIONable:CONDition? QUERY

STAT:QUES:COND?

Syntax: Short Form: STAT:QUES:COND? Long Form: STATus:QUESTIONable:CONDition?
 Return Value: <int_value> actual register value

Description: Returns the value of the Questionable Condition Register (see Table B-3). The Questionable Condition Register contains unlatched real-time information about questionable conditions of the power supply. Bit set to 1 = condition (active, true); bit reset to 0 = condition (inactive, false). (See example, Figure B-4.)

B.30 STATUS:QUESTIONABLE:ENABLE COMMAND**STAT:QUES:ENAB**

Syntax: Short Form: STAT:QUES:ENAB <int_value> Long Form: STATUS:QUESTIONABLE:ENABLE <int_value>

Description: **Programs Questionable Condition Enable Register (see Table B-3).** The Questionable Condition Enable Register determines which conditions are allowed to set the Questionable Condition Register; it is a mask for enabling specific bits in the Questionable Event register that can cause the questionable summary bit (bit 3) of the Status Byte register to be set. The questionable summary bit is the logical OR of all the enabled bits in the Questionable Event register. Bit set to 1 = function enabled (active, true); bit reset to 0 = function disabled (inactive, false). (See example, Figure B-4.)

B.31 STATUS:QUESTIONABLE:ENABLE? QUERY**STAT:QUES:ENAB?**

Syntax: Short Form: STAT:QUES:ENAB? Long Form: STATUS:QUESTIONABLE:ENABLE?
Return Value: <int_value> actual register value

Description: **Reads Questionable Condition Enable Register (see Table B-3).** Power supply returns value of Questionable Condition Enable Register, indicating which conditions are being monitored. Bit set to 1 = function enabled (active, true); bit reset to 0 = function disabled (inactive, false). Related Commands: STAT:QUES?. (See example, Figure B-4.)

B.32 STATUS:QUESTIONABLE:INSTRUMENT? QUERY**STAT:QUES:INST?**

Syntax: Short Form: STAT:QUES:INST? Long Form: STATUS:QUESTIONABLE:INSTRUMENT?
Return Value: <int_value> actual register value

Description: **Reads Questionable Instrument Register 0 (see Table B-4).** Unit returns value of Instrument Register 0 (inst register). The bits of this register are set when at least one bit in the specified channel's ISUM register was set previously and the specific enable bit was also set. When this register is read, bits 1 - 14 are cleared. Bit 0 which indicates the summary of the bits in Instrument Register 1 (inst1 register) remains set until the inst1 register is read.

TABLE B-4. QUESTIONABLE INSTRUMENT REGISTER 0 BITS

CONDITION	NU	CH 14	CH 13	CH 12	CH 11	CH 10	CH 9	CH 8	CH 7	CH 6	CH 5	CH 4	CH 3	CH 2	CH 1	INST1
BIT	15	14	13	12	11	10	9	8	7	6	5	4	3	2	1	0
VALUE	32768	16384	8192	4096	2048	1024	512	256	128	64	32	16	8	4	2	1

CH CHANNEL
NU NOT USED
INST1 INSTRUMENT REGISTER 1

B.33 STATUS:QUESTIONABLE:INSTRUMENT1? QUERY**STAT:QUES:INST1?**

Syntax: Short Form: STAT:QUES:INST1? Long Form: STATUS:QUESTIONABLE:INSTRUMENT1?
Return Value: <int_value> actual register value

Description: **Reads Questionable Instrument Register 1 (see Table B-5).** Unit returns value of Instrument Register 1 (inst1 register). The bits of this register are set when at least one bit in the specified channel's ISUM register was set previously and the specific enable bit was also set. When this register is read,

bits 1 - 14 are cleared. Bit 0 which indicates the summary of the bits in Instrument Register 2 (inst2 register) remains set until the inst2 register is read.

TABLE B-5. QUESTIONABLE INSTRUMENT REGISTER 1 BITS

CONDITION	NU	CH 28	CH 27	CH 26	CH 25	CH 24	CH 23	CH 22	CH 21	CH 20	CH 19	CH 18	CH 17	CH 16	CH 15	INST2
BIT	15	14	13	12	11	10	9	8	7	6	5	4	3	2	1	0
VALUE	32768	16384	8192	4096	2048	1024	512	256	128	64	32	16	8	4	2	1

CH CHANNEL
 NU NOT USED
 INST1 INSTRUMENT REGISTER 1

B.34 STATUS:QUESTIONABLE:INSTRUMENT2? QUERY

STAT:QUES:INST2?

Syntax: Short Form: STAT:QUES:INST2? Long Form: STATUS:QUESTIONABLE:INSTRUMENT2?
 Return Value: <int_value> actual register value

Description: **Reads Questionable Instrument Register 2 (see Table B-6).** Unit returns value of Instrument Register 2 (inst2 register). The bits of this register are set when at least one bit in the specified channel's ISUM register was set previously and the specific enable bit was also set. When this register is read, bits 1 - 14 are cleared.

TABLE B-6. QUESTIONABLE INSTRUMENT REGISTER 2 BITS

CONDITION	NU	CH 31	CH 30	CH 29	NU
BIT	15-4	3	2	1	0
VALUE	32768-16	8	4	2	1

CH CHANNEL
 NU NOT USED

STAT:QUES:INST:ENAB

B.35 STATUS:QUESTIONABLE:INSTRUMENT:ENABLE COMMAND

Syntax: Short Form: STAT:QUES:INST:ENAB <int_value>
 Long Form: STATUS:QUESTIONABLE:INSTRUMENT:ENABLE <int_value>

Description: **Programs Questionable Instrument Register 0 Enable Register (see Table B-3).** The Questionable Instrument Register 0 Enable Register is a mask which determines which channels are allowed to set Questionable Instrument Register 0.

STAT:QUES:INST:ENAB?

B.36 STATUS:QUESTIONABLE:INSTRUMENT:ENABLE QUERY

Syntax: Short Form: STAT:QUES:INST:ENAB?
 Long Form: STATUS:QUESTIONABLE:INSTRUMENT:ENABLE?
 Return Value: <int_value> actual register value.

Description: **Reads Questionable Instrument Register 0 Enable Register (see Table B-3).** Unit returns value of Questionable Instrument Register 0 Enable Register.

STAT:QUES:INST1:ENAB

B.37 STATUS:QUESTIONABLE:INSTRUMENT1:ENABLE COMMAND

Syntax: Short Form: STAT:QUES:INST1:ENAB <int_value>
 Long Form: STATUS:QUESTIONABLE:INSTRUMENT1:ENABLE <int_value>

Description: **Programs Questionable Instrument Register 1 Enable Register (see Table B-3).** The Questionable Instrument Register 1 Enable Register is a mask which determines which channels are allowed to set Questionable Instrument Register 1.

STAT:QUES:INST1:ENAB?

B.38 STATUS:QUESTIONABLE:INSTRUMENT1:ENABLE? QUERY

Syntax: Short Form: STAT:QUES:INST1:ENAB? Long Form: STATUS:QUESTIONABLE:INSTRUMENT1:ENABLE?
Return Value: <int_value> actual register value.

Description: **Reads Questionable Instrument Register 1 Enable Register (see Table B-3).** Unit returns value of Questionable Instrument Register 1 Enable Register.

STAT:QUES:INST2:ENAB

B.39 STATUS:QUESTIONABLE:INSTRUMENT2:ENABLE COMMAND

Syntax: Short Form: STAT:QUES:INST2:ENAB <int_value>
Long Form: STATUS:QUESTIONABLE:INSTRUMENT2:ENABLE <int_value>

Description: **Programs Questionable Instrument Register 2 Enable Register (see Table B-6).** The Questionable Instrument Register 2 Enable Register is a mask which determines which channels are allowed to set Questionable Instrument Register 2.

STAT:QUES:INST2:ENAB?

B.40 STATUS:QUESTIONABLE:INSTRUMENT2:ENABLE? QUERY

Syntax: Short Form: STAT:QUES:INST2:ENAB? Long Form: STATUS:QUESTIONABLE:INSTRUMENT2:ENABLE?
Return Value: <int_value> actual register value.

Description: **Reads Questionable Instrument Register 2 Enable Register (see Table B-3).** Unit returns value of Questionable Instrument Register 2 Enable Register.

B.41 STATUS:QUESTIONABLE:INSTRUMENT:ISUM QUERY STAT:QUES:INST:ISUM?

Syntax: Short Form: STAT:QUES:INST:ISUM? Long Form: STATUS:QUESTIONABLE:INSTRUMENT:ISUM?
Return Value: <int_value> actual register value

Description: **Reads ISUM Register (see Table B-3).** Unit returns value of ISUM Register for selected channel. This register is identical in function to the QUESTIONABLE register for the selected channel. This command requires that the SCPI compliant mode of operation for multiple logical instruments be enabled first by sending SYST:SET S1 (see PAR. B.51).

STAT:QUES:INST:ISUM:ENAB

B.42 STATUS:QUESTIONABLE:INSTRUMENT:ISUM:ENABLE COMMAND

Syntax: Short Form: STAT:QUES:INST:ISUM:ENAB <int_value>
Long Form: STATUS:QUESTIONABLE:INSTRUMENT:ISUM:ENABLE <int_value>

Description: **Programs Questionable Instrument ISUM Enable Register (see Table B-3).** The Questionable Instrument ISUM Enable Register is a mask which determines which conditions are allowed to set the Questionable Instrument ISUM Register for the selected channel. This command requires that the SCPI compliant mode of operation for multiple logical instruments be enabled first by sending SYST:SET S1 (see PAR. B.51).

STAT:QUES:INST:ISUM:ENAB?

B.43 STATUS:QUESTIONABLE:INSTRUMENT:ISUM:ENABLE? QUERY

Syntax: Short Form: STAT:QUES:INST:ISUM:ENAB?
Long Form: STATUS:QUESTIONABLE:INSTRUMENT:ISUM:ENABLE?
Return Value: <int_value> actual register value

Description: **Reads ISUM Enable Register (see Table B-3).** Unit returns value of ISUM Enable Register for selected channel. This command requires that the SCPI compliant mode of operation for multiple logical instruments be enabled first by sending SYST:SET S1 (see PAR. B.51).

B.44 SYSTEM:COMMunication:GPIB:ADDRess COMMAND SYST:COMM:GPIB:ADDR

Syntax: Short Form: SYST:COMM:GPIB:ADDR<INT VAL> 1 to 30
 Long Form: SYSTEM:COMMunication:GPIB:ADDRess<INT VAL> 1 to 30

Description: **Sets selected power supply GPIB address.**

B.45 SYSTEM:COMMunication:SERial:BAUD COMMAND SYST:COMM:SER:BAUD

Syntax: Short Form: SYST:COMM:SER:BAUD {19200 | 9600 | 4800 | 2400}
 Long Form: SYSTEM:COMMunication:SERial:BAUD {19200 | 9600 | 4800 | 2400}

Description: **Sets the unit to operate at the specified baud rate.**

B.46 SYSTEM:COMMunication:SERial:ECHO COMMAND SYST:COMM:SER:ECHO

Syntax: Short Form: SYST:COMM:SER:ECHO {ON | OFF}
 Long Form: SYSTEM:COMMunication:SERial:ECHO {ON | OFF}

Description: **Enables (ON) or disables (OFF) echo mode** (see PAR. 3.3.3.1) Sending ON causes all subsequent characters to be echoed back. Sending OFF turns off the character echo after the nest line terminator character. The *RST command has no effect on echo status

B.47 SYSTEM:COMMunication:SERial:PACe COMMAND SYST:COMM:SER:PACe

Syntax: Short Form: SYST:COMM:SER:PACe {NONE | XON}
 Long Form: SYSTEM:COMMunication:SERial:PACe {NONE | XON}

Description: **Enables (XON) or disables (NONE) data flow control via the serial interface** (see PAR. 3.3.3.3)

B.48 SYSTEM:COMMunication:SERial:PRoMpt COMMAND SYST:COMM:SER:PRoM

Syntax: Short Form: SYST:COMM:SER:PRoM {ON | OFF}
 Long Form: SYSTEM:COMMunication:SERial:PRoMpt {ON | OFF}

Description: **Enables (ON) or disables (OFF) prompt** (see PAR. 3.3.3.3). Sending ON causes the unit to return > character after the command is parsed.

B.49 SYSTEM:ERRor[:NEXT]? QUERY SYST:ERR?

Syntax: Short Form: SYST:ERR[:NEXT]? Long Form: SYSTEM:ERRor[:NEXT]?
 Return Value: <int_value,string>

Description: **Posts error messages to the output queue.** Returns the next error number followed by its corresponding error message string from the instrument error queue. The error queue is a FIFO (first in first out) buffer that stores errors as they occur. As it is read, each error is removed from the queue and the next error message is made available. When all errors have been read, the query returns 0,"No error". If more than 15 errors are accumulated, it will overflow. The oldest errors stay in the queue but the most recent errors are discarded. The last error in the queue will be -350,"Too many errors." Error messages are defined in Table B-7.

B.50 SYSTEM:LANGUage COMMAND SYST:LANG

Syntax: Short Form: SYST:LANG CIIL Long Form: SYSTEM:LANGUage CIIL

Description: **This command allows the CIIL command language to be used to program the power supply.** (CIIL is included to provide compatibility with earlier Kepco equipment.) Once CIIL is selected, the CIIL command 'GAL' followed by the command 'SCPI' must be sent for the power supply to respond to SCPI commands.

TABLE B-7. ERROR MESSAGES

ERROR MESSAGE	ESR ERROR BIT SET (SEE PAR. A.5)	EXPLANATION
0, "No error"	None	No error
-100, "Command error"	Command Error bit 5	Command and data understood, but more information included which is not recognized.
-102, "Syntax error"	Command Error bit 5	First 4 characters recognized, subsequent characters not recognized.
-103, "Invalid separator"	Command Error bit 5	For example, VOLT.10 received instead of VOLT:10
-108, "Parameter Not Allowed Error"	Command Error bit 5	Volt12 sequence, channel number is invalid
-109, "Missing parameter"	Command Error bit 5	For example, VOLT instead of VOLT 21.
-111, "Header separator error"	Command Error bit 5	Missing space between volt and value or ; missing
-113, "Undefined header"	Command Error bit 5	First 4 characters could not be identified as legal command. For example, command VLT instead of VOLT
-120, "Numeric data error"	Command Error bit 5	Expected number but other characters were detected
-121, "Invalid character in number"	Command Error bit 5	Volt 1,500 (comma not allowed)
-123, "Exponent too large"	Command Error bit 5	Exponent E+3 or greater is invalid.
-141, "Invalid character data"	Command Error bit 5	For example OUTP OFD or OUTP STOP instead of OUTP OFF
-150, "String data error"	Command Error bit 5	Invalid characters were detected in numeric entry. For example E.1 instead of E+1 or 4d3 instead of 4.3.
-222, "Data out of range"	Execution error bit 4	Value exceeds power supply rating
-223, "Data format error"	Execution error bit 4	Multiple decimals in digit, Multiple E, etc.
-224, "Illegal parameter value"	Execution error bit 4	For example, OUTP 2 instead of OUTP 1
-241, "Hardware missing"	Execution error bit 4	Requesting device 2 status (INST:NSEL 2)
-350, "Queue overflow"	Device Error bit 3 (1)	More than 15 errors are in queue.
-410, "Query interrupted"	Query Error bit 2	New command sent before data from previous query read. Previous query data lost.
-430, "Query Deadlocked"	Query Error bit 2	Over 255 characters received in single input string"
(1) The Device error bit may be set when the status monitoring functions of the power supply detect an overvoltage/under-voltage condition.		

B.51 SYSTem:SET COMMAND

SYST:SET

Syntax: Short Form: SYSTem:SET {CM0 | CM1 | SI0 | SI1} Long Form: SYSTem:SET {CM0 | CM1}

Description: Sending SYST:SET CM1 sets the unit to operate in compatible mode and have all GPIB functions compatible with software version 1.2 and lower units. Sending SYST:SET CM0 sets the unit to be fully SCPI 1997 compliant.

The selection of the status reporting structure is controlled by the SYST:SET SI (Instrument Structure) command, either SI0 (off) or SI1 (on). The power-up default is the off condition. To enable the SCPI compliant mode of operation for multiple logical instruments the user must send SYST:SET SI1 to the MST 488-27 during initialization. The SI1 state is not remembered when the unit is turned off. To return to the standard method of reporting the selected device's status without turning the unit off, send SYSTem:SET SI0(see PAR. 3.4.8.4).

B.52 SYSTem:VERSION QUERY

SYST:VERS?

Syntax: Short Form: SYST:VERS? Long Form: SYSTem:VERSION?
Return Value: <int_value>.<int_value> (YYYY.V)

Description: **Identifies SCPI Version implemented.** Returns SCPI Version number: YYYY = year, V = Revision number for specified year (e.g 1997,0.).

APPENDIX C - CIIL COMMAND DEFINITIONS

C.1 INTRODUCTION

This appendix defines the CIIL commands used with the MST 488-27 Controller. Table C-1 provides a quick reference of all CIIL commands used in the MST 488-27 Controller.

TABLE C-1. CIIL SUBSYSTEM COMMAND/QUERY INDEX

COMMAND	PAGE	COMMAND	PAGE
CLS	C-4	OPN	C-4
CNF	C-4	RST	C-4
FNC	C-1	SET	C-3
FTH	C-2	SRN	C-3
INX	C-2	SRX	C-3
IST	C-4	STA	C-5

The MST 488-27 can also accept five special commands from the host controller. These commands (listed below) are enabled by first sending the sequence `GAL`. Switching from CIIL to SCPI or SCPI to CIIL clears this flag, disabling the special sequences.

- `GTL` - go to local
- `DCL` - device clear (reset power supply to 0 volts)
- `CIIL` - switch to CIIL mode
- `SCPI` - switch to SCPI mode
- `REN` - go to remote mode

FNC

Syntax: Stimulus mode: `FNC DCS :CHnn <SET Command>`
 Sensor mode: `FNC DCS <VOLT or CURR command> :CHnn`

Function: This operator is used with either the `SET` command to program a power supply's output (stimulus mode), or with the `VOLT` and `CURR` commands to read its output settings (sensor mode).

Description: The first operand contains the three (3) letter mnemonic pertaining to the device on the control bus, in this case `DCS` (Direct Current Source). If a reading is being set up, the modifier `VOLT` or `CURR` follows. The next operand is used to select the specific channel of the device being programmed or read from. The controller can control up to 27 power supplies/power modules with control bus addresses in the range of 1 to 31.

Example:

<code>FNC DCS :CH12 SET VOLT 15</code>	Power supply at node address 12 commanded to 15V
<code>FNC DCS :CH12 SET CURR 3</code>	Power supply at node address 12 commanded to 3A
<code>FNC DCS VOLT :CH03</code>	Power supply at node address 3 returns value which represents actual output voltage
<code>FNC DCS CURR :CH21</code>	Power supply at node address 21 returns value which represents actual output current

NOTE: Actual output voltage and current depends on whether output is enabled or disabled and load conditions

FIGURE C-1. FNC — FUNCTION COMMAND

INX

Syntax: INX VOLT (initiate voltage reading)
INX CURR (initiate current reading)

Function: Commences a data acquisition process in accordance with the preceding FNC command.

Description: The response to the INX command is a dynamic time-out value, unless a catastrophic error condition exists, in which case an error message will be returned. If the time-out value returned is not zero, this indicates the power supply's output voltage or current has not yet settled. A time delay should be observed before proceeding with the FTH command, or the command may be repeated until a zero value is returned, but the preceding FTH command must also be repeated.

Example: INX VOLT Power supply initiates voltage reading)
FTH VOLT Power supply sends voltage reading to controller)

FIGURE C-2. INX — INITIATE OP CODE COMMAND

FTH

Syntax: FTH VOLT (fetch voltage reading)
FTH CURR (fetch current reading)

Function: Commands the previously designated power supply to return the requested data reading.

Description: This command must immediately follow an INX command. The value returned is the value of the output voltage or current, whichever was requested, unless a catastrophic error condition exists, in which case an error message will be returned. The value observed will be in scientific notation.

Example: INX VOLT Power supply initiates voltage reading)
FTH VOLT Power supply sends voltage reading to controller)

FIGURE C-3. FTH — FETCH COMMAND

OPN, CLS

Syntax:	<code>OPN :CHnn</code> <code>CLS :CHnn</code>
Function:	These commands are used to connect or disconnect the power supply from the load (for MBT, effective for MR and MGR options only).
Description:	<code>OPN</code> Disconnects the load from the power supply specified by the operand. <code>CLS</code> Connects the load to the power supply specified by the operand.
Example:	<code>OPN :CH22</code> Opens the relay of the power supply at node address 22. <code>CLS :CH14</code> Closes the relay of the power supply at node address 14.

FIGURE C-5. OPN, CLS — OPEN, CLOSE RELAY COMMANDS

RST

Syntax:	<code>RST DCS :CHnn</code>
Function:	This operator is used to return a power supply to its power-on state. The output voltage and current are programmed to zero and the output relay is opened (for MBT this applies to MR and MGR models only).
Example:	<code>RST DCS :CH13</code> The power supply at node address 13 is reset.

FIGURE C-6. RST — RESET COMMAND

CNF, IST

Syntax:	<code>CNF</code> or <code>IST</code>
Function:	Causes power supply to execute confidence test.
Description:	The CNF operator commands the power supply to execute the confidence test procedure defined for that power supply (<code>IST</code> is functionally identical to <code>CNF</code>). The procedure consists of opening all power relays, programming voltage and current to their maximum values, switching polarity, checking for error flags, then programming voltage and current to zero. The results of CNF are obtained through the STA command.
Example:	<code>CNF</code> All power supplies in the daisy chain execute confidence test. <code>IST</code> All power supplies in the daisy chain execute self test.

FIGURE C-7. CNF, IST — CONFIDENCE TEST, INTERNAL SELF TEST COMMANDS

STA

Syntax: STA

Function: Causes power supply to return operating status to controller.

Description: This operator commands the power supply to report its present operating status. Status is reported in the form of a message (character string) as defined below. Any catastrophic error conditions (indicated by * in the table below) which exist will be reported, until the error condition is corrected. As required by CIIL, all error messages begin with an ASCII "F" (Fault) followed by a 2 digit code, "07" (Halt). The code that follows (DCSnn) indicates the type of device and the channel number. The next 3 digit code describes the nature of the fault: "DEV" for device related errors or "MOD" for non-device errors, such as syntax.

TABLE C-2. CIIL ERROR MESSAGES

ERROR MESSAGE	EXPLANATION
F07 DCSnn DEV Power Loss	The power supply has lost its input power. *
F07 DCSnn DEV Crowbarred (MAT, MBT)	A shutdown occurred due to overvoltage or overcurrent. *
F07 DCSnn DEV Device Turned Off (BOP)	
F07 DCSnn DEV Output Fault (MST)	
F07 DCSnn DEV Over Temperature	A shutdown occurred due to thermal causes. *
F07 DCSnn DEV Overload	The voltage or current limit point was exceeded. *
F07 DCSnn DEV Voltage Fault	The output voltage is not within limits (voltage mode). *
F07 DCSnn DEV Current Fault	The output current is not within limits (current mode). *
F07 DCSnn DEV Relay Not Opened	The power relay failed to open. *
F07 DCSnn DEV Relay Not Closed	The power relay failed to close. *
F07 DCSnn DEV Polarity Error	The output polarity is not correct. *
F07 DCSnn DEV Load Path Fault	Open or miswired load or error sense leads detected. *
F07 DCSnn MOD Invalid Command	Improper syntax was used. **
F07 DCSnn DEV Not Ready	The output voltage or current has not settled. **
F07 DCSnn DEV Device Not Present	The specified power supply was not present during power up or during the last DCL. **
F07 DCSnn DEV Device Not Responding	The power supply has failed to communicate to the controller. **
F07 DCSnn DEV Invalid Voltage Range	The programmed voltage is outside the power supply's range. **
F07 DCSnn DEV Invalid Current Range	The programmed current is outside the power supply's range. **
F07 DCSnn DEV Set Modifier Error	An improper SET command was sent. **
F07 DCSnn DEV Invalid Device ID	The selected channel was not between 1-31. **
* Catastrophic error	
** Non-Catastrophic error	

FIGURE C-8. STA — STATUS COMMAND

You must register your product to comply with the terms of the warranty. Either fill out the form below and mail or fax to Kepco, or for rapid on-line registration go to:

<http://www.kepcopower.com/warranty.htm>

PRODUCT PURCHASED:

Model Number) _____

Serial Number _____

PURCHASE INFORMATION:

Date Purchased: _____

Date Received: _____

REQUEST ADDITIONAL INFORMATION

Send complete Catalog

Have Sales Engineer Call

Contact via: E-Mail Telephone Fax S-mail

REGISTER TO:

Registered by: _____

Company Name: _____

Street: _____

City: _____

State: _____

Country: _____

Zip: _____

E-mail: _____

FAX: _____

Phone: _____

WHAT INFLUENCED YOUR CHOICE OF THIS POWER SUPPLY?

Previous Experience (which Kepco Models do you have?)

Magazines (which ones?)

Trade Shows (which ones?)

Directory?

Kepco Catalog or Brochure? _____

Sales Representative?

Web Site

Other (please explain): _____

What products would you like to see Kepco make?

CUT HERE

Kepco 5 Year Warranty

This is to certify that we, KEPCO, INC., (hereinafter called "Company"), Flushing, NY 11352 USA, warrants for a period of FIVE YEARS, this instrument known as:

MODEL: _____

SERIAL NO. _____

The Company's products are warranted for a period of five years from date of delivery to be free from defects in materials and workmanship and to conform to the specifications furnished or approved by the Company. Liability under this warranty shall be limited to the repair or replacement of any defective product at Company's option.

If any defect within this warranty appears within the warranty period, the Purchaser shall promptly notify the Company in writing. No material will be accepted for repair or replacement without written authorization of the Company.

Upon such authorization, and in accordance with instructions of the Company, parts or materials for which replacement is requested shall be returned to the Company for examination, with shipping charges prepaid by the Purchaser. Final determination as to whether a product is actually defective rests with the Company.

This warranty does not extend to any product which has been subjected to misuse, neglect, accident, improper installation, or use in violation of instructions furnished by the Company. The warranty does not extend to, or apply to, any unit which has been repaired or altered outside of the Company's factory by persons not expressly approved by the Company.

THE WARRANTY HEREIN CONTAINED IS IN LIEU OF AND EXCLUDES ALL OTHER WARRANTIES, EXPRESS, IMPLIED OR STATUTORY, INCLUDING WITHOUT LIMITATION THE WARRANTY OF MERCHANTABILITY.

THIS KEPCO PRODUCT IS WARRANTED FOR FIVE YEARS!

KEPCO, INC. • 131-38 SANFORD AVENUE, FLUSHING,
NY 11352 USA • Tel. 718-461-7000 • Fax. 718-767-1102
E-mail: hq@kepcopower.com • URL: <http://www.kepcopower.com>



FOLD HERE

Please
place
stamp
here

KEPCO, INC.

131-38 SANFORD AVE.
FLUSHING, NY 11352 USA

CUT HERE